

STANDARD HORIZON

Nothing takes to water like Standard Horizon

EXPLORER SERIES GX1600 and GX1700

25 Watt VHF/FM
Marine Transceiver

Owner's Manual

- Ultra thin and compact rear case design (3.5" depth)
 - Meets ITU-R M493-13 Class D DSC (Digital Selective Calling)
 - Integrated 66 Channel WAAS GPS receiver (GX1700)
 - GPS antenna built-in to the front panel allows reception when bracket or flush mounted (GX1700)
 - Navigation to a DSC Distress Call with compass page
 - DSC test call and Auto DSC channel change selection
 - Automatically poll the GPS position of up to 4 ships using DSC
 - Enter, Save, and Navigation to a waypoint with Compass page *
 - Navigation (LAT/LON, SOG, and COG) information shown on display *
 - Submersible JIS-8 class 1.5M (4.92Ft) for 30 minutes
 - Noise canceling microphone with channel selection, 16/9 and H/L keys
 - NOAA weather channel selection with alert
 - Programmable Scan, Priority Scan, and Dual Watch
 - Preset key stores up to 10 favorite channels, with scan function
 - Oversized dot matrix display with customizable channel names and GPS Compass display
 - NMEA Input and Output of GPS information to other NMEA compatible devices
 - Programmable soft keys
 - Capable of connecting to a Second Station Remote-Access Microphone CMP31
 - Die-cast chassis
 - Dimensions: 5.9" W x 3.4" H x 3.6" D
 - Flush mount cutout: 5.4" W x 2.8" H x 2.6" D
 - 3 Year Waterproof Warranty
- * When connected to an optional GPS for GX1600



EXPLORER GPS GX1700

TABLE OF CONTENTS









Quick Reference Guide.....	4	8.11.1 Communication.....	37
1 GENERAL INFORMATION.....	5	8.11.2 Calling.....	37
2 PACKING LIST.....	5	9 DIGITAL SELECTIVE CALLING.....	38
3 OPTIONAL ACCESSORIES.....	5	9.1 GENERAL.....	38
4 ON-LINE WARRANTY REGISTRATION		9.2 MARITIME MOBILE SERVICE IDENTITY (MMSI).....	38
(in USA or Canada only).....	6	9.2.1 What is an MMSI?.....	38
5 GETTING STARTED.....	7	9.2.2 Programming the MMSI.....	39
5.1 PROHIBITED COMMUNICATIONS.....	7	9.3 DSC DISTRESS ALERT.....	40
5.2 ABOUT VHF RADIO.....	7	9.3.1 Transmitting a DSC Distress Alert.....	40
5.3 SELECTING AN ANTENNA.....	7	9.3.2 Receiving a DSC Distress Call.....	43
5.4 COAXIAL CABLE.....	8	9.4 ALL SHIPS CALL.....	45
5.5 EMERGENCY (CHANNEL 16 USE).....	8	9.4.1 Transmitting an All Ships Call.....	45
5.6 CALLING ANOTHER VESSEL (CHANNEL 16 OR 9).....	9	9.4.2 Receiving an All Ships Call.....	46
5.7 MAKING TELEPHONE CALLS.....	10	9.5 INDIVIDUAL CALL.....	47
5.8 OPERATING ON CHANNELS 13 AND 67.....	10	9.5.1 Setting up the Individual / Position Call Directory.....	47
5.9 AUTOMATED RADIO CHECK SERVICE.....	10	9.5.2 Setting up the Individual Call Reply.....	48
6 INSTALLATION.....	12	9.5.3 Setting up the Individual Call Acknowledgment.....	49
6.1 SAFETY / WARNING INFORMATION.....	12	9.5.4 Transmitting an Individual Call.....	50
6.2 LOCATION.....	12	9.5.5 Receiving an Individual Call.....	52
6.3 MOUNTING THE RADIO.....	13	9.5.6 Setting up the Individual Call Ringer.....	53
6.3.1 Supplied Mounting Bracket.....	13	9.6 GROUP CALL.....	55
6.3.2 Optional MMB-97 Flush Mount Bracket.....	14	9.6.1 Setting up the Group Call.....	55
6.4 ELECTRICAL CONNECTIONS.....	15	9.6.2 Transmitting a Group Call.....	57
6.5 ACCESSORY CABLE.....	16	9.6.3 Receiving a Group Call.....	59
6.5.1 GX1700 Internal GPS (DSC Output to a Chart Plotter)		9.6.4 Setting up the Group Call Ringer.....	60
(RS422 Connections).....	17	9.7 POSITION REQUEST.....	61
6.5.2 GX1600 and GX1700 Connection to External GPS or Chart		9.7.1 Setting up the Position Reply.....	61
Plotter (for GPS) (RS422 Connections).....	17	9.7.2 Transmitting a Position Request to Another Vessel.....	62
6.6 CHECKING GPS STATUS.....	20	9.7.3 Receiving a Position Request.....	64
6.7 CHANGING THE GPS TIME.....	21	9.7.4 Setting up the Position Request Ringer.....	65
6.8 CHANGING THE TIME AREA.....	22	9.8 POSITION REPORT.....	66
6.9 CHANGING THE TIME DISPLAY.....	22	9.8.1 Transmitting a DSC Position Report Call.....	66
6.10 CHANGING COG TO TRUE OR MAGNETIC.....	23	9.8.2 Receiving a DSC Position Report Call.....	68
6.11 OPTIONAL RAM3+ (CMP31) INSTALLATION.....	23	9.8.3 Navigating to a Position Report.....	68
6.11.1 Connecting an External Speaker to the RAM3+ Mic		9.8.4 Stopping Navigation to a Position Report.....	69
Cable.....	25	9.8.5 Saving a Position Report Call as a Waypoint.....	69
6.11.2 External Speaker AF Selection.....	25	9.8.6 Navigating to a Saved Waypoint.....	69
7 CONTROLS AND INDICATORS.....	26	9.8.7 Stopping Navigation to a Saved Waypoint.....	70
7.1 FRONT PANEL.....	26	9.8.8 Setting up the Position Report Ringer.....	70
7.2 REAR PANEL.....	28	9.9 MANUAL INPUTTING A GPS POSITION (LAT/LON).....	71
7.3 MICROPHONE.....	29	9.10 AUTO POS POLLING.....	72
8 BASIC OPERATION.....	30	9.10.1 Setting up the Polling Time Interval.....	72
8.1 RECEPTION.....	30	9.10.2 Selecting Stations to be Automatically Polled (Tracked).....	72
8.2 TRANSMISSION.....	30	9.10.3 Enable/Disable Auto POS Polling.....	73
8.3 TRANSMIT TIME - OUT TIMER (TOT).....	30	9.11 DSC TEST CALL.....	74
8.4 SIMPLEX/DUPLEX CHANNEL USE.....	31	9.11.1 Programming MMSI into Individual/Position Call	
8.5 DISPLAY TYPE.....	31	Directory.....	74
8.6 USA, CANADA, AND INTERNATIONAL MODE.....	32	9.11.2 DSC Test Call by using Individual/Position Call	
8.7 NOAA WEATHER CHANNELS.....	32	Directory.....	74
8.7.1 NOAA Weather Alert.....	32	9.11.3 DSC Test Call by Manually Entering a MMSI.....	75
8.7.2 NOAA Weather Alert Testing.....	33	9.12 POLLING CALL.....	76
8.8 DUAL WATCH (TO CHANNEL 16).....	33	9.12.1 Transmitting a Polling Call to Another Vessel.....	76
8.9 SCANNING.....	34	9.12.2 Receiving a Polling Call.....	77
8.9.1 Scan Type Selection.....	34	9.13 DSC LOG OPERATION.....	78
8.9.2 Scan and P-Scan Memory Programming.....	34	9.13.1 Reviewing and Resending a Transmitted Logged Call.....	78
8.9.3 Memory Scanning (M-SCAN).....	35	9.13.2 Reviewing DSC Distress Logged Calls.....	79
8.9.4 Priority Scanning (P-SCAN).....	35	9.13.3 Reviewing Other Logged Calls.....	79
8.10 PRESET CHANNELS (0 - 9): INSTANT ACCESS.....	36	9.13.4 Deleting a Call from the "DSC LOG" Directory.....	80
8.10.1 Preset Channel Programming.....	36	10 GENERAL SETUP.....	81
8.10.2 Operation.....	36	10.1 DISPLAY.....	81
8.10.3 Deleting a Preset Channel.....	36	10.2 DIMMER ADJUSTING.....	82
8.11 INTERCOM OPERATION.....	37	10.3 CONTRAST.....	82

TABLE OF CONTENTS

10.4	UNIT OF MEASURE.....	83	18	WARRANTY.....	121
10.5	MAGNETIC.....	84	19	RESET PROCEDURES.....	125
10.6	KEY BEEP.....	84	19.1	MEMORY CLEAR.....	125
10.7	STATION NAME.....	85	19.2	MICROPROCESSOR RESET.....	125
10.8	SOFT KEYS.....	86	20	SPECIFICATIONS.....	126
10.8.1	Selecting the Number of Soft Keys.....	86	20.1	GENERAL.....	126
10.8.2	Assigning Soft Keys.....	86	20.2	TRANSMITTER.....	126
10.8.3	Selecting How Long the Soft Keys are Shown.....	87	20.3	RECEIVER.....	127
11	CHANNEL FUNCTION SETUP.....	88	20.4	GPS UNIT (GX1700).....	127
11.1	CHANNEL GROUP (USA, CANADA or INTERNATIONAL BAND SELECTION).....	88	20.5	NMEA INPUT/OUTPUT.....	127
11.2	SCAN MEMORY CHANNEL.....	88	20.6	DIMENSIONS.....	128
11.3	SCAN TYPE.....	89	21	FCC RADIO LICENSE INFORMATION.....	130
11.4	SCAN RESUME.....	90	21.1	STATION LICENSE.....	130
11.5	PRIORITY CHANNEL.....	91	21.2	RADIO CALL SIGN.....	130
11.6	WEATHER ALERT.....	91	21.3	CANADIAN SHIP STATION LICENSING.....	130
11.7	CHANNEL NAME.....	92	21.4	FCC / INDUSTRY CANADA INFORMATION.....	130
12	DSC SETUP.....	93	22	FCC NOTICE.....	131
12.1	INDIVIDUAL DIRECTORY.....	93			
12.2	INDIVIDUAL REPLY.....	93			
12.3	INDIVIDUAL ACKNOWLEDGMENT.....	93			
12.4	INDIVIDUAL RINGER.....	93			
12.5	GROUP DIRECTORY.....	93			
12.6	POSITION REPLY.....	94			
12.7	AUTO POSITION INTERVAL.....	94			
12.8	DSC BEEP.....	94			
12.9	AUTO CHANNEL SWITCH TIME.....	95			
12.10	NO ACTION TIMER ON MENU OPERATION.....	95			
12.11	NO ACTION TIMER ON DSC OPERATION.....	96			
12.12	NO ACTION TIMER ON DISTRESS OPERATION.....	96			
13	WAYPOINTS.....	97			
13.1	MARKING A POSITION.....	97			
13.2	ADDING A WAYPOINT.....	98			
13.3	EDITING A WAYPOINT.....	99			
13.4	DELETING A WAYPOINT.....	100			
13.5	SAVING A DSC POSITION CALL AS A WAYPOINT.....	100			
13.6	NAVIGATING TO A SAVED WAYPOINT.....	101			
13.7	STOP NAVIGATING TO A WAYPOINT.....	101			
13.8	WAYPOINT SETUP.....	102			
13.8.1	Waypoint Range Selection.....	102			
13.8.2	Direction Selection.....	102			
14	GPS SETUP.....	103			
14.1	UNIT POWER (GX1700).....	103			
14.2	COORDINATE SYSTEM.....	104			
14.3	PINNING (GX1700).....	104			
14.4	TIME OFFSET.....	105			
14.5	TIME AREA.....	105			
14.6	TIME DISPLAY.....	105			
14.7	MAGNETIC.....	105			
14.8	POSITION INPUT.....	105			
14.9	GPS SELECTION (GX1700).....	105			
14.10	SBAS (Satellite Based Augmentation System) (GX1700).....	106			
14.11	NMEA OUTPUT (GX1700).....	107			
15	RAM3+ (CMP31) REMOTE MIC OPERATION.....	108			
15.1	REMOTE MIC CONTROLS.....	108			
15.2	ASSIGNING SOFT KEYS.....	110			
16	MAINTENANCE.....	112			
16.1	REPLACEMENT PARTS.....	112			
16.2	FACTORY SERVICE.....	113			
16.3	TROUBLESHOOTING CHART.....	114			
17	CHANNEL ASSIGNMENTS.....	115			



QUICK REFERENCE GUIDE

The **GX1600** and **GX1700** are equipped with the E2O (Easy-To-Operate) system. You can do the basic operation in numerical order in the illustration below.

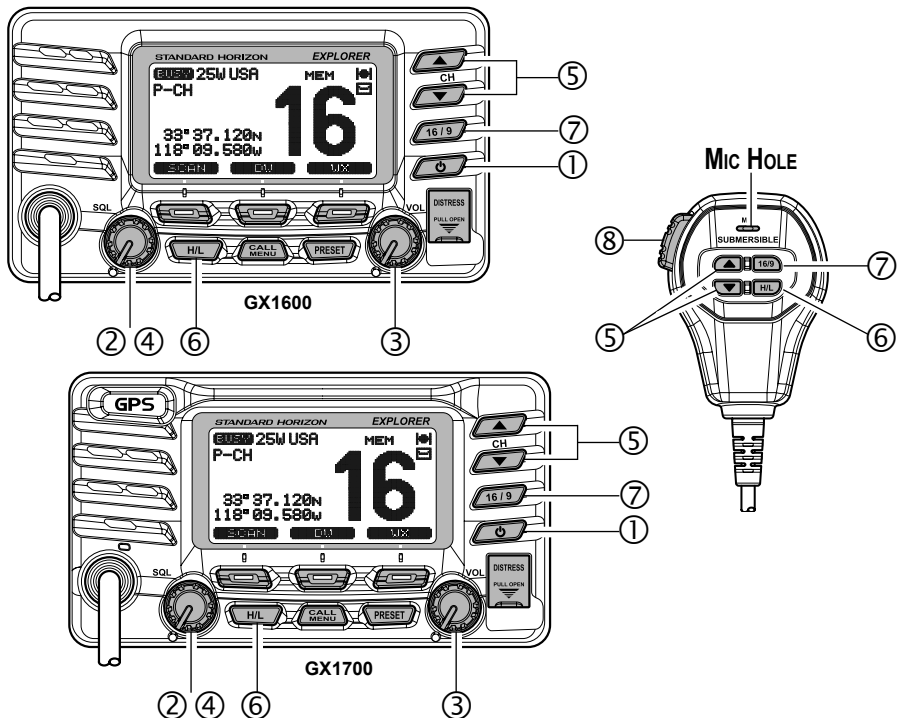
- ① Press and hold the  button to turn on or off the radio.
- ② Rotate the **SQL** knob counter clockwise to unsquelch the radio.
- ③ Rotate the **VOL** knob to adjust the speaker audio volume.
- ④ Rotate the **SQL** knob clockwise to the point where the noise not heard from the speaker.
- ⑤ Press the  (or microphones ) button to select the operating channel.
- ⑥ Press the  (or microphones ) button to toggle the transmit power between High (25W) and Low (1W).
- ⑦ Press the  (or microphones ) button to recall channel 16. Press and hold the  (or microphones ) button to recall channel 9. Press again to revert to the last selected channel.
- ⑧ Place your mouth about 1/2 inch away from Mic hole and speak in a normal voice level while pressing the **PTT** switch.



1 GENERAL INFORMATION

The STANDARD HORIZON EXPLORER Series **GX1600** and **GX1700** marine VHF/FM marine transceivers are capable of ITU-R 493-13 DSC (Digital Selective Calling) class D operation. The class D operation allows continuous receiving of digital selective calling functions on channel 70 even if the radio is receiving a call. The **GX1600** and **GX1700** VHF's operate on all currently-allocated marine channels which are switchable for USA, International, or Canadian regulations. Emergency channel 16 can be immediately selected from any channel by pressing the red  key. NOAA Weather channels can also be accessed immediately by pressing the  soft key.

The **GX1600** and **GX1700** can be operated from 11 to 16 VDC and have a switchable RF output power of 1 watt or 25 watts.

Other features of the **GX1600** and **GX1700** VHF's include: Slim design only 3.5" deep, noise canceling microphone with controls, optional **RAM3+** second station remote-control microphone with display, intercom between radio and optional **RAM3+**, scanning, priority scanning, dual watch, DSC position polling up to 4 vessels, high and low voltage warning, and GPS repeatability.

In addition, the **GX1700** integrates a 66-channel internal GPS receiver.

2 PACKING LIST

When the package containing the transceiver is first opened, please check it for the following contents:

- **GX1600** or **GX1700** Transceiver
- Power Cord with Fuse Holder
- Mounting Bracket and hardware
- Owner's Manual
- DSC Warning Sticker
- Flush Mount Template

3 OPTIONAL ACCESSORIES

HC1600	Dust Cover (White)
MMB-97	Flush-Mount Bracket
CMP31B/W	Remote-Access Microphone (RAM3+ Mic, Black/White)
CT-100	23-foot Extension Cable for RAM3+ Mic
MLS-310	10W amplified External Speaker with on/off Volume control
MLS-300	External Loud Speaker
Q7000619A	External GPS antenna with 30Ft of cable

4 ON-LINE WARRANTY REGISTRATION (in USA or Canada only)

Please visit www.standardhorizon.com to register the **GX1600/GX1700** marine VHF. It should be noted that visiting the website from time to time may be beneficial to you, as new products are released they will appear on the STANDARD HORIZON website.

PRODUCT SUPPORT INQUIRIES

If you have any questions or comments regarding the use of the **GX1600/GX1700**, you can visit the STANDARD HORIZON website to send an E-Mail (marinetech@yaesu.com) or contact the Product Support team at (800) 767-2450 M-F 8:00AM to 5:00PM PST.

5 GETTING STARTED

5.1 PROHIBITED COMMUNICATIONS

The FCC prohibits the following communications:

- False distress or emergency messages;
- Messages to “any boat” except in emergencies and radio tests;
- Messages to or from a vessel on land;
- Transmission while on land;
- Obscene, indecent, or profane language (potential fine of \$10,000).

5.2 ABOUT VHF RADIO

The radio frequencies used in the VHF marine band lie between 156 and 158 MHz with some shore stations available between 161 and 163 MHz. The marine VHF band provides communications over distances that are essentially “line of sight” (VHF signals do not travel well through objects such as buildings, hills or trees). Actual transmission range depends much more on antenna type, gain and height than on the power output of the transmitter. On a fixed mount 25W radio transmission expected distances can be greater than 15 miles.

5.3 SELECTING AN ANTENNA

Marine antennas are made to radiate signals equally in all horizontal directions, but not straight up. The objective of a marine antenna is to enhance the signal toward the horizon. The degree to which this is accomplished is called the antenna’s gain. It is measured in decibels (dB) and is one of the major factors in choosing an antenna. In terms of effective radiated power (ERP), antennas are rated on the basis of how much gain they have over a theoretical antenna with zero gain. A 3 foot, 3dB gain antenna represents twice as much gain over the imaginary antenna.

Typically a 3 foot 3dB gain stainless steel whip is used on a sailboat mast. The longer 8 foot 6dB fiberglass whip is primarily used on power boats that require the additional gain.

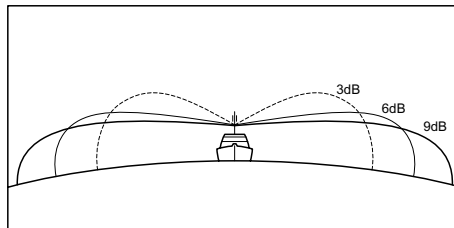

5.4 COAXIAL CABLE

VHF antennas are connected to the transceiver by means of a coaxial cable – a shielded transmission line. Coaxial cable is specified by its diameter and construction.

For runs less than 20 feet, RG-58/U, about 1/4 inch in diameter is a good choice. For runs over 20 feet but less than 50 feet, the larger RG-8X or RG-213/U should be used for cable runs over 50 feet RG-8X should be used. For installation of the connector onto the coaxial cable refer to the figure below.

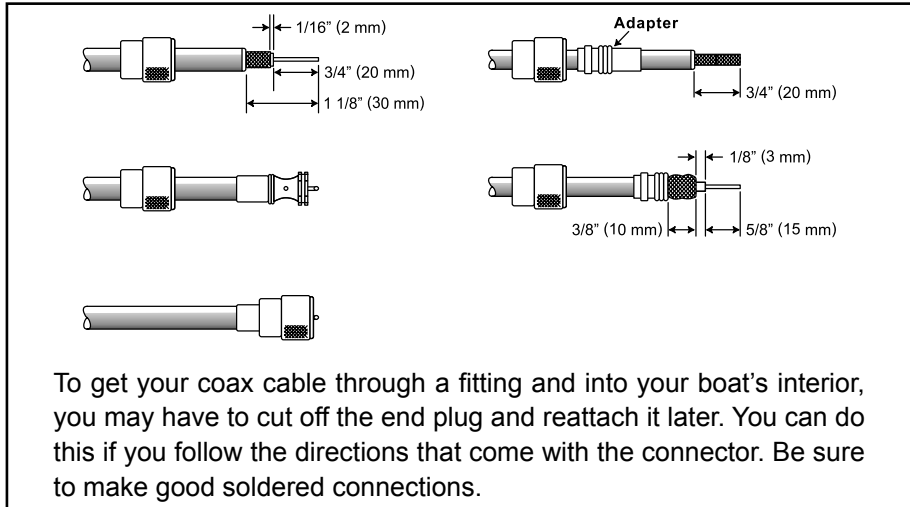

5.5 EMERGENCY (CHANNEL 16 USE)

Channel 16 is known as the Hail and Distress Channel. An emergency may be defined as a threat to life or property. In such instances, be sure the transceiver is on and set to CHANNEL 16. Then use the following procedure:

1. Press the microphone push-to-talk switch and say "**Mayday, Mayday, Mayday**. This is _____, _____, _____" (your vessel's name).
2. Then repeat once: "**Mayday**, _____" (your vessel's name).
3. Now report your position in latitude/longitude, or by giving a true or magnetic bearing (state which) to a well-known landmark such as a navigation aid or geographic feature such as an island or harbor entry.
4. Explain the nature of your distress (sinking, collision, aground, fire, heart attack, life-threatening injury, etc.).
5. State the kind of assistance your desire (pumps, medical aid, etc.).

6. Report the number of persons aboard and condition of any injured.
7. Estimate the present seaworthiness and condition of your vessel.
8. Give your vessel's description: length, design (power or sail), color and other distinguishing marks. The total transmission should not exceed 1 minute.
9. End the message by saying "**OVER**". Release the microphone button and listen.
10. If there is no answer, repeat the above procedure. If there is still no response, try another channel.

NOTE

The **GX1600** and **GX1700** have DSC distress calling, that can transmit a distress call digitally to all ships with compatible DSC radios. Refer to section "**9 DIGITAL SELECTIVE CALLING**".

5.6 CALLING ANOTHER VESSEL (CHANNEL 16 OR 9)

Channel 16 may be used for initial contact (hailing) with another vessel. However, its most important use is for emergency messages. This channel must be monitored at all times except when actually using another channel.

Channel 16 is monitored by the U.S. and Canadian Coast Guards and by other vessels. **Use of channel 16 for hailing must be limited to initial contact only.** Calling should not exceed 30 seconds, but may be repeated 3 times at 2-minute intervals. In areas of heavy radio traffic, congestion on channel 16 resulting from its use as a hailing channel can be reduced significantly in U.S. waters by using **channel 9** as the initial contact (hailing) channel for non-emergency communications. Also hailing on channel 9, the calling time should not exceed 30 seconds but may be repeated 3 times at 2-minute intervals.

Prior to making contact with another vessel, refer to the channel charts in this manual, and select an appropriate channel for communications after initial contact. For example, Channels 68 and 69 of the U.S. VHF Charts are some of the channels available to non-commercial (recreational) boaters. Monitor your desired channel in advance to make sure you will not be interrupting other traffic, and then go back to either channel 16 or 9 for your initial contact.

When the hailing channel (16 or 9) is clear, press the **PTT** button on the mic and state the name of the other vessel you wish to call and then "**this is**" followed by the name of your vessel and your Station License (Call Sign) then release the **PTT** button on the mic. When the other vessel returns your call, immediately request another channel by pressing the **PTT** button on

the mic and saying “**go to**,” the number of the other channel, say “**over**” and release the **PTT** button on the mic. Then switch to the new channel. When the new channel is not busy, call the other vessel.

After a transmission, say “**over**,” and release the microphone’s push-to-talk (**PTT**) switch. When all communication with the other vessel is completed, end the last transmission by stating your Call Sign and the word “**out**.” Note that it is not necessary to state your Call Sign with each transmission, only at the beginning and end of the contact.

Remember to return to Channel 16 when not using another channel. Some radios automatically monitor Channel 16 even when set to other channels or when scanning.

5.7 MAKING TELEPHONE CALLS

To make a radiotelephone call, use a channel designated for this purpose. Check with your local marina to learn which channels are used for radiotelephone traffic. Channels available for such traffic are designated **Public Correspondence** channels on the channel charts in this manual. Some examples for USA use are the channels 24, 25, 26, 27, 28, 84, 85, 86, and 87. Call the marine operator and identify yourself by your vessel’s name, the marine operator will then ask you how you will pay for the call (telephone credit card, collect, etc.) and then link your radio transmission to the telephone lines.

The marine telephone company managing the VHF channel you are using may charge a link-up fee in addition to the cost of the call.

5.8 OPERATING ON CHANNELS 13 AND 67

Channel 13 is used at docks, bridges and by vessels maneuvering in port. Messages on this channel must concern navigation only, such as meeting and passing in restricted waters.

Channel 67 is used for navigational traffic between vessels.

By regulation, power is normally limited to 1 Watt on these channels. Your radio is programmed to automatically reduce power to this limit on these channels. However, in certain situations it may be necessary to temporarily use a higher power. See page 26 ( key) for means to temporarily override the low-power limit on these two channels.

5.9 AUTOMATED RADIO CHECK SERVICE

In areas across the country, Sea Tow offers boaters a way to conduct radio checks. To use Sea Tow’s free Automated Radio Check service, simply tune

your VHF radio to the appropriate channel for your location and conduct a radio check as you typically would. Upon releasing your radio's microphone, the system will play an automated message and relay your transmission back to you, thereby letting you know how your signal will sound to other boaters.

The Automated Radio Check Service is currently available in the areas listed below.

West Coast	South Carolina
Newport/LA - Ch. 27	Charleston - Ch. 27
San Diego - Ch. 27	Georgetown - Ch. 27
Northeast	Myrtle Beach - Ch. 27
Central Connecticut - Ch. 24	Gulf of Mexico
Eastern Connecticut - Ch. 27	Galveston Bay - Ch. 27
Southern Connecticut - Ch. 24	Mobile - Ch. 26
Portland-Midcoast (Maine) - Ch. 27	New Orleans - Ch. 27
Boston - Ch. 27	Pensacola/Orange Beach (Ala.) - Ch. 27
Cape and Islands - Ch. 28	Georgia
South Shore (Mass.) - Ch. 26	Brunswick - Ch. 27
Rhode Island - Ch. 24	Tennessee
Central Hudson (NY) - Ch. 24	Fort Loudon - Ch. 28
Eastern Long Island - Ch. 28	Florida
Freeport (N.Y.) - Ch. 24	Carrabelle/St. Marks - Ch. 26 & 27
Great South Bay (N.Y.) - Ch. 27	Charlotte Harbor - Ch. 26
Lower New York - Ch. 28	Clearwater/Port Richey - Ch. 26 & 27
Huntington (N.Y.) - Ch. 28	Daytona - Ch. 26
Port Jefferson - Ch. 27	Destin - Ch. 26 & 27
Shinnecock / Moriches (N.Y.) - Ch. 24 & 27	Fort Lauderdale - Ch. 27
Services International (Southold) - Ch. 28	Fort Myers - Ch.27
Western LI Sound - Ch. 27	Horseshoe Beach - Ch. 26
Manasquan (N.J.) - Ch. 24	Islamorada - Ch. 26
Northern New Jersey - Ch. 27	Jacksonville - Ch. 27
Mid-Atlantic	Key Biscayne - Ch. 26
Atlantic City (NJ) - Ch. 26	Key Largo - Ch. 27
Central New Jersey (NJ) - Ch. 27	Marco Island - Ch. 27
Sea Isle / Cape May (NJ) - Ch. 26	Naples - Ch. 26
Delaware River (DE) - Ch. 26	Palm Beach - Ch. 26
Northern Chesapeake (Md.) - Ch. 27	Panama City - Ch. 27
Central Chesapeake (Md.) - Ch. 27	Pensacola - Ch. 26 & 27
Lower Chesapeake(Va.) - Ch. 26	Port Canaveral - Ch. 26
Hampton Roads (Va.) - Ch. 28	Port St. Joe - Ch. 26
North Carolina	Sarasota - Ch. 26
Albermarle Sound- Ch. 27	Sebastian - Ch. 27
Crystal Coast- Ch. 27	St. Augustine - Ch. 26
Ocean Isle Beach - Ch. 26	Services International (Summerland Keys) - Ch. 27
Oregon Inlet- Ch. 27	Tampa Bay - Ch. 27
Pamlico Sound - Ch. 27	Treasure Coast - Ch. 27
Wrightsville Beach - Ch. 26 & 27	Venice - Ch. 27
Puerto Rico	Virgin Islands
Puerto Rico - Ch. 26 & 27	Virgin Islands - Ch. 27

6 INSTALLATION

6.1 SAFETY / WARNING INFORMATION

This radio is restricted to occupational use, work related operations only where the radio operator must have the knowledge to control the exposure conditions of its passengers and bystanders by maintaining the minimum separation distance of 3 feet (1 m). Failure to observe these restrictions will result in exceeding the FCC RF exposure limits.

Antenna Installation:

The antenna must be located at least 3 feet (1 m) away from passengers in order to comply with the FCC RF exposure requirements.

6.2 LOCATION

The radio can be mounted at any angle. Choose a mounting location that:

- is far enough from any compass to avoid any deviation in compass reading due to the speaker magnet
- provides accessibility to the front panel controls
- allows connection to a power source and an antenna
- has nearby space for installation of a microphone hanger
- is at least 3 feet (1 m) away from the radio's antenna.
- the signal from the GPS satellite can receive sufficiently (**GX1700**).

Note: To insure the radio does not affect the compass or radios performance is not affected by the antenna location, temporarily connect the radio in the desired location and:

- a. Examine the compass to see if the radio causes any deviation
- b. Connect the antenna and key the radio. Check to ensure the radio is operating correctly by requesting a radio check.

6.3 MOUNTING THE RADIO

6.3.1 Supplied Mounting Bracket

The supplied mounting bracket allows overhead or desktop mounting.

See illustration on next page, use a 13/64" (5.2 mm) bit to drill the holes to a surface which is more 0.4 inch (10 mm) thick and can support more than 3.3 lbs (1.5 kg) and secure the bracket with the supplied screws, spring washers, flat washers, and nuts.

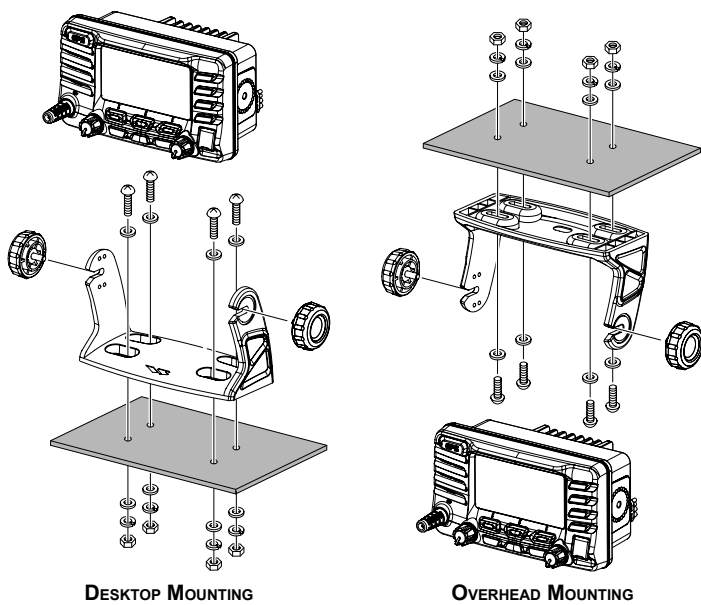

6.3.2 Optional MMB-97 Flush Mount Bracket

1. Use the supplied template to mark the location where the rectangular hole is to be cut. Confirm the space behind the dash or panel is deep enough to accommodate the transceiver (at least 3.54 inches (90 mm) deep). There should be at least 1/2 inch (1.3 cm) between the transceiver's heatsink and any wiring, cables or structures.
2. Cut out the rectangular hole 2.82" H x 5.39" W (72 x 137 mm) and insert the transceiver.
3. Fasten the brackets to the rear panel of the transceiver (see illustration at the right).
4. Turn the adjusting screw to adjust the tension so that the transceiver is tight against the mounting surface.

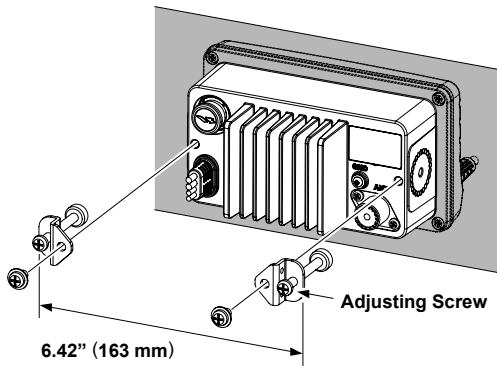

NOTE (GX1700)

A GPS receiver and antenna of the **GX1700** is located in the front panel. In many cases the radio may be flush mounted, however before cutting holes to flush mount the radio it is recommended to temporarily connect the radio to power and turn on in the location where it will be flush mounted to confirm it is able to receive a GPS location on it's display. If the radio is not able to receive a location, a GPS Chart plotter with NMEA 0183 output or the optional Standard Horizon external GPS antenna may be needed to receive GPS satellite signals.

To use the optional Standard Horizon external GPS antenna (Q7000619A), the **GX1700** internal GPS Unit Power must be turned OFF (refer to section "**14.1 UNIT POWER (GX1700)**") and the GPS Selection changed to External GPS (refer to section "**14.9 GPS SELECTION (GX1700)**").

6.4 ELECTRICAL CONNECTIONS

CAUTION

Reverse polarity battery connections will damage the radio!

Connect the power cord and antenna to the radio. Antenna and Power Supply connections are as follows:

1. Mount the antenna at least 3 feet (1 m) away from the radio. At the rear of the radio, connect the antenna cable. The antenna cable must have a PL259 connector attached. RG-8/U coaxial cable must be used if the antenna is 25 feet (7.6 m) or more from the radio. RG58 cable can be used for distances less than 25 feet (7.6 m).
2. Connect the red power wire to a 11.0 V to 16.5 V DC power source (Normal: 13.8 VDC). Connect the black power wire to a negative ground.
3. If an optional remote extension speaker is to be used, refer to section “**6.5 ACCESSORY CABLE**” for connections.
4. It is advisable to have a Certified Marine Technician check the power output and the standing wave ratio of the antenna after installation.

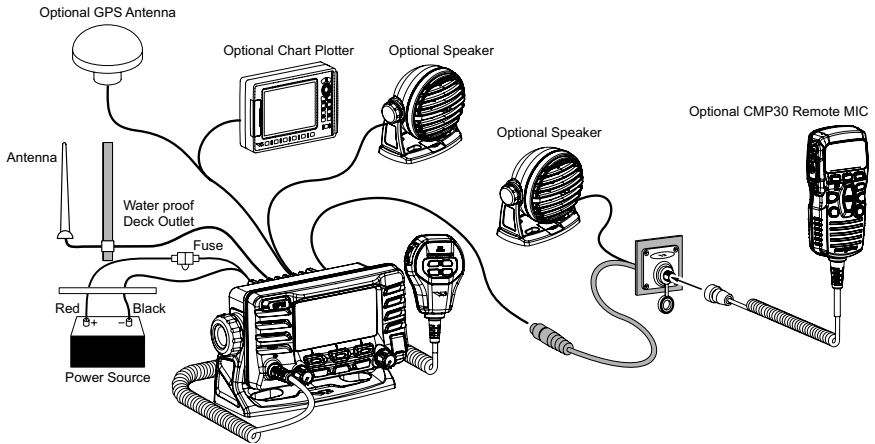

Fuse Replacement (125V 6A)

To take out the fuse from the fuse holder, hold both ends of the fuse holder and pull the fuse holder apart without bending the fuse holder. When you replace the fuse, please confirm that the fuse is tightly fixed on the metal contact located inside the fuse holder. If the metal contact holding the fuse is loose, the fuse holder may heat up.

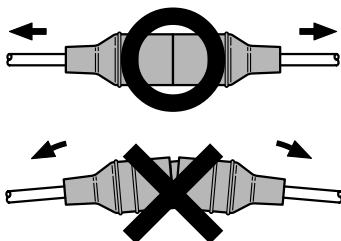

6.5 ACCESSORY CABLE

Wire Color/Description	Connection Examples
WHITE - External Speaker (+)	Connect to external 4 Ohm audio speaker
SHIELD - External Speaker (-)	Connect to external 4 Ohm audio speaker
BLUE - NMEA GPS Input (+)	Connect to NMEA (+) output of GPS
GREEN - NMEA GPS Input (-)*	Connect to NMEA (-) output or common ground of GPS
GRAY - NMEA DSC Output (+)	Connect to NMEA (+) input of GPS
BROWN - NMEA GPS Output (-)*	Connect to NMEA (-) input of GPS

※: Some GPS chart plotters have a single wire for NMEA signal ground. In such a case connect the NMEA input (-) to the GPS chart plotter's single NMEA signal ground wire, and leave the NMEA output (-) open. In case the assignment of power supply and ground of a GPS chart plotter to be used is different from that of the radio, connect the signal ground wire of the GPS chart plotter to the ground terminal (GND) on the rear panel of the radio.

When connecting the external speaker, chart plotter, or external GPS antenna, strip off about 1 inch (2.5 cm) of the specified wire's insulation, then splice the ends together.

6.5.1 GX1700 Internal GPS (DSC Output to a Chart Plotter) (RS422 Connections)

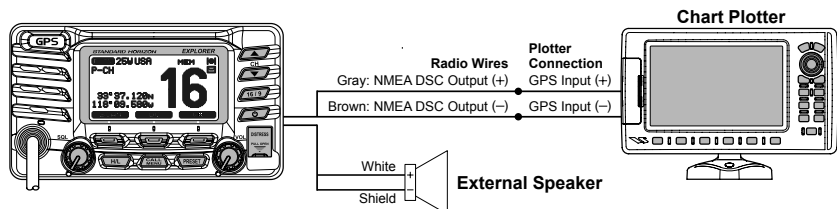

6.5.2 GX1600 and GX1700 Connection to External GPS or Chart Plotter (for GPS) (RS422 Connections)

The connections below are used for the **GX1600**, or the **GX1700** when the internal GPS cannot receive a Fix. The **GX1700** internal GPS must be turned off (refer to section “**14.1 UNIT POWER (GX1700)**”) and the GPS selection must be set to “External GPS” (refer to section “**14.9 GPS SELECTION (GX1700)**”).

6.5.2.1 GPS Input - Standard Horizon GPS Antenna

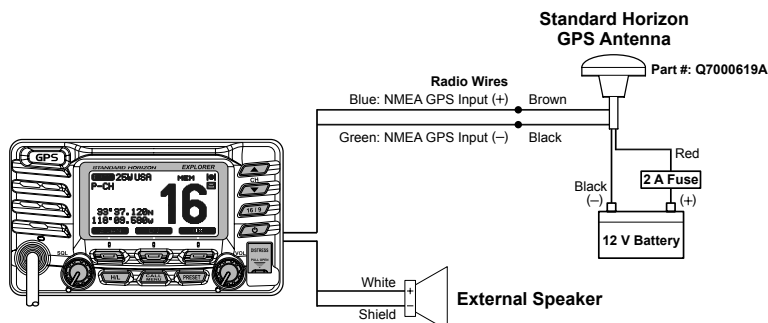

Note: The GPS antenna is supplied with 30ft of cable and a connector. To connect the GPS antenna to the radio, cut off the 5 pin antenna connector, strip the white insulation to expose the red, black and brown wires and connect as shown in the diagram. All other wires are not used and may be cut off. The 2 amp fuse is not included.

6.5.2.2 GPS Input and DSC Output GPS Chart Plotter (RS422 Connections)

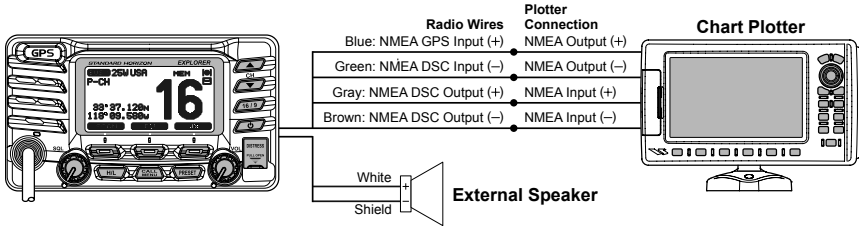

6.5.2.3 Standard Horizon GPS Chart Plotter or Other Chart Plotter (RS232 Connections)

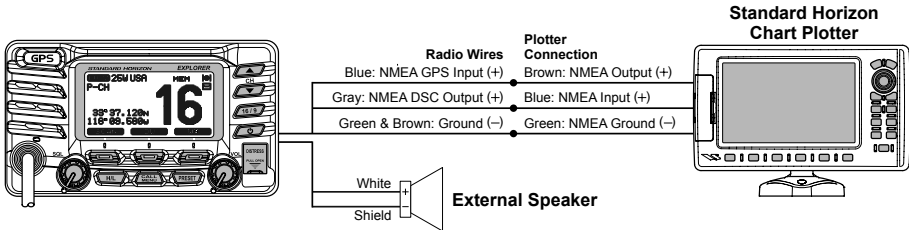

NOTE

In the RS232 connections, the assignment of DC ground of the chart plotter needs to be the same as that of the **GX1600** and **GX1700**.

CAUTION

Care must be taken not to touch any of the NMEA wires (blue, gray or brown) to positive 12 VDC or the radio may be damaged.

External GPS Connections (4800 baud)

NMEA Input (GPS Information)

- The GPS must have the NMEA output turned on and set to 4800 baud in the setup menu. If there is a selection for parity select none.
- For further information on interfacing /setting up your GPS. Please contact the manufacturer of the GPS receiver.
- The **GX1600** and **GX1700** can read NMEA-0183 version 2.0 or higher.
- The NMEA 0183 input sentences are GSA, GSV, GLL, GGA, RMC and GNS (RMC sentence is recommended for position information).

NMEA Output (DSC and GPS Information)

- The NMEA 0183 output sentences are DSC and DSE.
- GSA, GSV, GLL, GGA, and RMC sentences can be output in the **GX1700** by setting through the GPS setup menu (refer to section “**14.11 NMEA OUTPUT (GX1700)**”).

If you have further inquires, please feel free to contact Product Support at:

Phone: (800) 767-2450

Email: marinetech@yaesu.com

NOTE (GX1700)

When the GPS reception is limited, such as the flush mounting of the **GX1700**, the NMEA input (+) (blue) and NMEA input (-) (green) wires may be connected to the NMEA output connections of an external GPS antenna or a GPS chart plotter. To change the **GX1700** from using the internal GPS antenna to the external GPS antenna, refer to section “**14.9 GPS SELECTION (GX1700)**” (for selection), and “**14.1 UNIT POWER (GX1700)**” (for turn off).

6.6 CHECKING GPS STATUS

After connections have been made between the **GX1600** and the GPS, or when the **GX1700** receives the GPS signal from the internal GPS, or from an external GPS antenna or chart plotter, a small satellite icon (📶)* will appear on the top right corner of the display and your current location (latitude/longitude) is shown on the display.

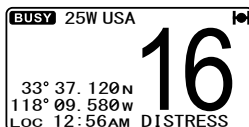

*: When the **GX1700** receives the GPS signal from an external GPS antenna or chart plotter, the “IO” icon will appear instead.

NOTE

If there is a problem with the NMEA connection between the radio and the GPS, the GPS icon will blink continuously until the connection is corrected.

The **GX1600** and **GX1700** have a GPS status display which shows the satellites currently being received, along with a graphical (bar-graph) representation of the relative signal strengths from the satellites.

NOTE

For the **GX1600** and **GX1700** to properly show the GPS status page when an external GPS antenna or a chart plotter is connected it must be setup to output GSA and GSV NMEA 0183 sentences.

1. Press and hold the **CALL MENU** key until “Setup Menu” appears, then select “GENERAL SETUP” with the **▲/▼** key.
2. Press the **SELECT** soft key, then select “DISPLAY” with the **▲/▼** key.
3. Press the **SELECT** soft key, then select “GPS STATUS” with the **▲/▼** key.
4. Press the **ENT** soft key to display the GPS status currently being received.
5. Press any key to return to normal operation.

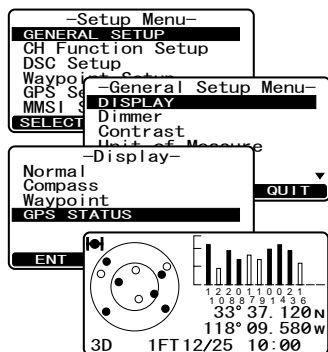

NOTE (GX1700)

When the **GX1700** is first turned on, it may take several minutes to compute a fix of your position. This is normal, as the **GX1700** is downloading “almanac” information from the GPS satellites.

6.7 CHANGING THE GPS TIME

From the factory the **GX1600**, when connected to an optional GPS, and the **GX1700** will display GPS satellite time or UTC (Universal Time Coordinated). A time offset is needed to show the local time in your area. Please see the time offset table at the bottom of this page.



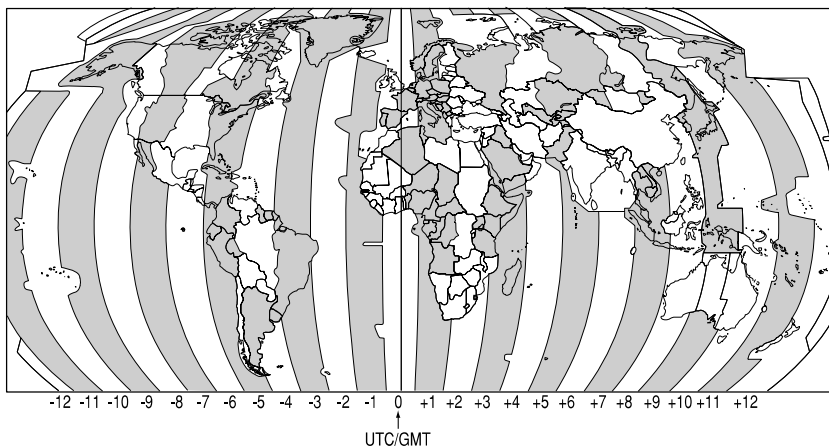
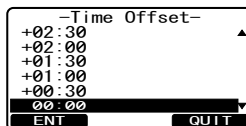
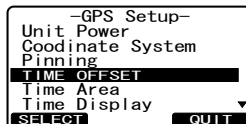
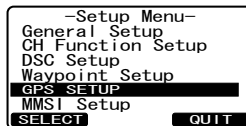
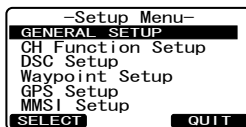



1. Press and hold the **CALL MENU** key until "Setup Menu" appears, then select "GPS SETUP" with the **UP** / **DOWN** key.
2. Press the **SELECT** soft key, then select "TIME OFFSET" with the **UP** / **DOWN** key.
3. Press the **SELECT** soft key, then press the **UP** / **DOWN** key to select time offset of your location. See illustration below to find your offset time. If "00:00" is assigned, the time is the same as UTC (Universal Time Coordinated or GPS Satellite Time).
4. Press the **ENT** soft key to store the time offset.
5. Press the **QUIT** soft key twice to return to radio operation.



TIME OFFSET TABLE

6.8 CHANGING THE TIME AREA





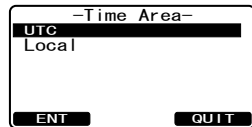
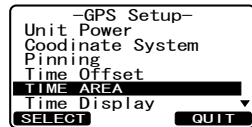
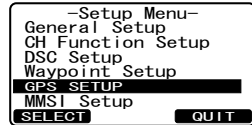
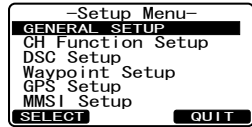

This menu selection allows the radio to show UTC (Universal Time Coordinated or GPS Satellite Time) or local time with the offset.

1. Press and hold the  key until "Setup Menu" appears, then select "GPS SETUP" with the  /  key.
2. Press the **SELECT** soft key, then press the  /  key to "TIME AREA".
3. Press the **SELECT** soft key.
4. Press the  /  key to select "UTC" or "LOCAL".
5. Press the **ENT** soft key to store the selected setting.
6. Press the **QUIT** soft key twice to return to radio operation.



6.9 CHANGING THE TIME DISPLAY





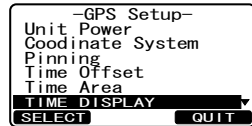
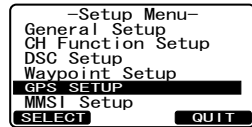
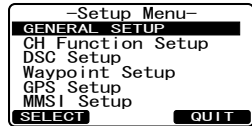

This menu selection allows the radio to setup to show time in 12-hour or 24-hour format.

1. Press and hold the  key until "Setup Menu" appears, then select "GPS SETUP" with the  /  key.
2. Press the **SELECT** soft key, then press the  /  key to select "TIME DISPLAY".
3. Press the **SELECT** soft key.
4. Press the  /  key to select "12 HOUR" or "24 HOUR".
5. Press the **ENT** soft key to store the selected setting.
6. Press the **QUIT** soft key twice to return to radio operation.



6.10 CHANGING COG TO TRUE OR MAGNETIC

Allows the GPS COG (Course Over Ground) to be selected to show in “True” or “Magnetic”. Factory default is “True” however by following the steps below the COG can be changed to “Magnetic”.

1. Press and hold the  key until “Setup Menu” appears, then select “GPS SETUP” with the  /  key.
2. Press the **SELECT** soft key, then press the  /  key to select “MAGNETIC”.
3. Press the **SELECT** soft key.
4. Press the  /  key to select “MAGNETIC” or “TRUE”.
5. Press the **ENT** soft key to store the selected setting.
6. Press the **QUIT** soft key twice to return to radio operation.

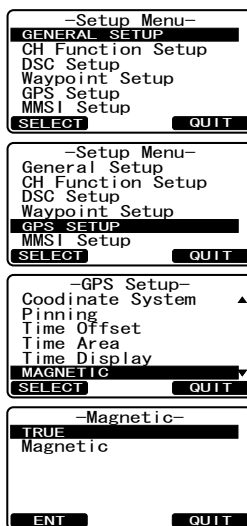

NOTE

Setting to “Magnetic” is effective only when the RMC sentences with magnetic data are input from external devices such as a GPS receiver. It is ineffective when using the internal GPS of the **GX1700**.

6.11 OPTIONAL RAM3+ (CMP31) INSTALLATION

The **GX1600** and **GX1700** are capable of connecting a **RAM3+ (CMP31)** Remote Station Microphone to remotely control the radio and DSC functions. In addition the **GX1600** and **GX1700** can operate as a full function intercom system between the **RAM3+** and the radio.

WARNING

Do not connect or remove RAM3+ (CMP31) mic while radio is powered on. This may result in equipment failure.

1. Connect the extension cable to the remote microphone eight pin connector on the rear panel, then tighten the cable nut (see illustration at the right).

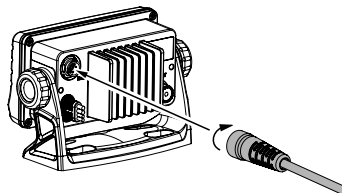

2. Install the ferrite core (supplied with the **RAM3+ (CMP31)** Remote Station Microphone) to the extension cable, then snap its two halves together, per the illustration on the next page.
3. Attach the ferrite core as close as possible to the MIC plug, as shown below.
4. Finally, wind some plastic tape around each ferrite core, to prevent vibration from causing the two halves to split apart.
5. Referring to illustration below, make a 1.2" (30 mm) hole in the wall, then insert the extension cable into this hole. Connect the gasket and mount base to the extension cable connector using the nut.
6. Drill the four screw holes (approx. 2 mm) on the wall, then install the mounting base to the wall using four screws.
7. Put the rubber cap on to the nut. The installation is now complete.

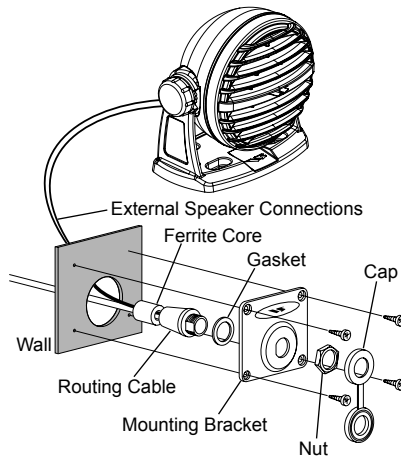
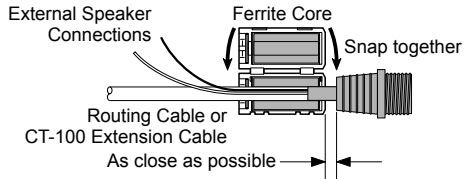











NOTE

The routing cable can be cut and spliced, however care needs to be taken when reconnecting the wires to ensure water integrity. Before cutting the cable make sure it is not plugged into the radio. After cutting you will notice there are the following wires:
 Brown, Gray, Blue, Green, White*, Shield*

* The white and shield wires are wrapped in foil. Remove the foil, and separate the white and shield wires.

6.11.1 Connecting an External Speaker to the RAM3+ Mic Cable





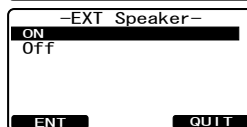
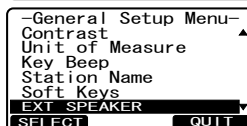
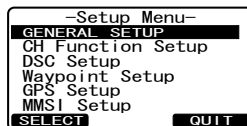





In noisy locations an optional external speaker may be connected to the white and black speaker wires on the **RAM3+** routing cable (refer to previous page). The **RAM3+** can drive the internal speaker or the external speaker one at a time. When connecting an external speaker, follow the procedure below to turn off the **RAM3+** audio and enable the external speaker wires on the **RAM3+** routing cable.

1. On the RAM3+ mic, press and hold the  key until "Setup Menu" appears, then select "GENERAL SETUP" with the  /  key.
2. Press the  soft key.
3. Press the  key to until "EXT SPEAKER" is shown and press the  soft key.
4. Press the  or  key to select "OFF" (External speaker off) or "ON" (External speaker on).
5. Press the  soft key to save the selection.
6. Press the  key to exit this mode.



6.11.2 External Speaker AF Selection

The "AF Select" menu allows you to set the audio output level of the **RAM3+** external speaker wires (on routing cable) to a fixed level regardless of the volume level setting of the **RAM3+**. This is useful when using the optional **MLS-310** amplified speaker with on/off volume control.

1. On the RAM3+ mic, press and hold the  key until "Setup Menu" appears, then select "GENERAL SETUP" with the  /  key.
2. Press the  soft key.
3. Press the  key to until "AF SELECT" is shown and press the  soft key.
4. Press the  or  key to select "PRE - OUT" (External Speaker Level is "Fixed") or "PA-OUT" (External Speaker Level is "Adjustable").
Use "Fixed" when **MLS-310** is connected.
Use "Adjustable" when **MLS-300** or other speaker without volume control is connected.
5. Press the  soft key to save the selection.
6. Press the  key to exit this mode.

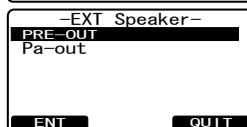
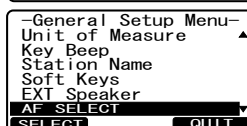
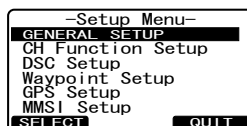

7 CONTROLS AND INDICATORS

NOTE

This section defines each control of the transceiver. For operating instructions refer to section “8 BASIC OPERATION”.

7.1 FRONT PANEL

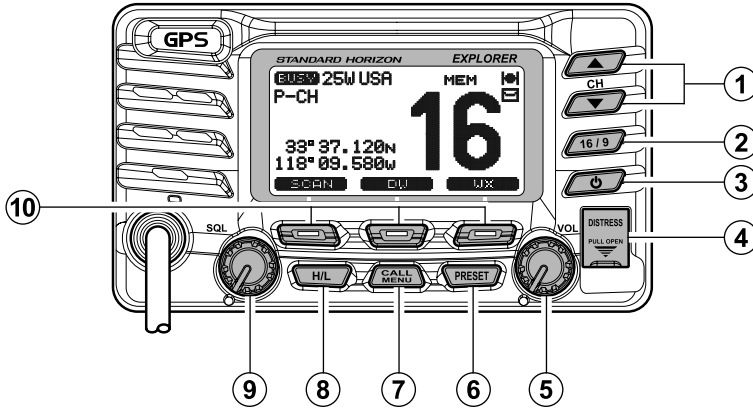

Note: The figure above shows the outline of the GX1700.

① Keys

The keys are used to select channels and to choose menu items (such as the DSC menu, General Setup and DSC Setup menu).

keys on the microphone can also be used to select channels and menu items.

SECONDARY USE

While holding down the **SCAN** soft key and pressing key, you can confirm memory channels that have been programmed for scanning.

















② Key

Press the key briefly to recall channel 16 from any channel.

Press and hold the key to recall channel 9. Pressing the key again reverts to the previous selected working channel.

③ Key

Turns the transceiver on and off. To turn the transceiver on, press and hold this key until the LCD turns on. To turn it off, press and hold this key until the LCD turns off. When the power is turned on, the transceiver is set to the last-selected channel.

- 4  Key
Used to send a DSC distress alert. To transmit a distress alert refer to section “**9.2.2 Programming the MMSI**” and “**9.3.1 Transmitting a DSC Distress Alert**”.
- 5 **VOL** Knob (Volume Control Knob)
Adjusts the audio volume level. Turn this knob clockwise to increase the audio volume level.
SECONDARY USE
When a **RAM3+** is connected and intercom mode is selected, controls the listen volume of the audio from the **RAM3+**.
- 6  Key
Press this key to select the preset memory bank, “**P SET**” will be shown on the display. To exit preset memory bank, press the  key again or press the  key. Press the  or  key to select the desired preset channel. Refer to section “**8.10.1 Preset Channel Programming**” to program the preset channels.
- 7  Key
Press the  key to access the “DSC Menu”.
SECONDARY USE
Press and hold the  key to access the “Setup Menu”.
- 8  Key
Press the  key to toggle between 25 W (High) and 1 W (Low) power. Channel 16 and 67 (navigation/bridge channels) are set to 1 W, however when the  key is pressed the power on these channels may be temporarily changed to 25 W until the **PTT** on the microphone is pressed and released. The  key does not function on transmit inhibited and low power only channels.
- 9 **SQL** Knob (Squelch Control)
Adjusting this control clockwise, sets the point at which random noise on the channel does not activate the audio circuits but a received signal does. This point is called the squelch threshold. Further adjustment of the squelch control will degrade reception of wanted transmissions.
- 10 Soft Keys
The 3 programmable soft keys can be customized by the Setup Menu mode described in the section “**10.8 SOFT KEYS**”. When one of the soft keys is pressed briefly, the functions will appear above each key on the display. The factory defaults are Key 1: , Key 2: , and Key 3:  function.

7.2 REAR PANEL

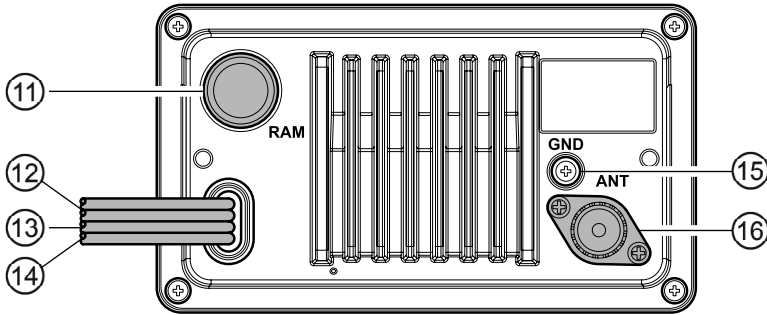



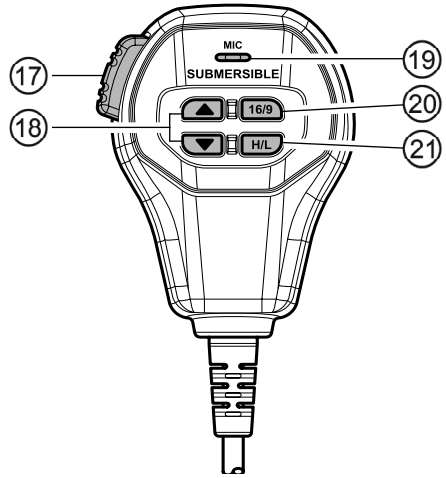

- ⑪ **RAM3+** Connector (Remote Station Microphone Connector)
Connects the **GX1600** or **GX1700** to the **RAM3+ (CMP31)** Remote Station Microphone. Refer to section “**15 RAM3+ (CMP31) REMOTE MIC OPERATION**” for details
- ⑫ DC Input Cable
Connects the radio to a DC power supply capable of delivering 11 to 16V DC.
- ⑬ Accessory Connection Cable (Green, Blue, Gray, & Brown)
Connects the **GX1600** or **GX1700** to a chart plotter or external GPS antenna. Refer to section “**6.5 ACCESSORY CABLE**”.
- ⑭ External Speaker Connection Cable (White & Shield)
Connects the **GX1600** or **GX1700** to an external speaker. See section “**3 OPTIONS**” for a list of optional STANDARD HORIZON speakers.
- ⑮ **GND** Terminal (Ground Terminal)
Connecting a ground wire to this connection will help reduce engine noise when receiving and transmitting.
Use the screw supplied with the radio only.
- ⑯ **ANT** Jack (Antenna Jack)
Connects an antenna to the transceiver. Use a marine VHF antenna with an impedance of 50 ohms.

7.3 MICROPHONE







- ①⑦ **PTT (Push-To-Talk) Switch**
When in radio mode and the **PTT** switch pressed, the transmitter is enabled for voice communications to another vessel.
When an optional **RAM3+** second station microphone is connected and intercom mode is selected, pressing the **PTT** switch enables voice communications from the **GX1600** or **GX1700** to the **RAM3+** second station microphone.



- ①⑧  /  Keys
The  /  keys on the microphone are used to select channels and to choose menu items (such as the DSC menu, General Setup and DSC Setup menu).
- ①⑨ **Microphone**
When spoken into transmits your voice with reduction of background noise, using Clear Voice Noise Reduction Technology.



NOTE

Be sure your mouth is about 1/2 inch (1.3 cm) from the mic hole for best performance.

- ②⑩  Key
The  key on the microphone functions the same as the  key on the front panel of the transceiver.
Immediately recalls channel 16 from any channel location. Pressing and holding this key recalls channel 9. Pressing the  key again reverts to the previously selected working channel.
- ②⑪  Key
The  key on the microphone functions the same as the  key on the front panel of the transceiver.
Press this key to toggle the transmit output power between 25 W (High) and 1 W (Low) power.

8 BASIC OPERATION

8.1 RECEPTION

1. After the transceiver has been installed, ensure that the power supply and antenna are properly connected.
2. Press and hold the  key until the radio turns on.
3. Rotate the **SQL** knob fully counterclockwise until "**BUSY**" is shown on the display. This state is known as "unsquelched".
4. Rotate the **VOL** knob until noise or audio from the speaker is at a comfortable level.
5. Rotate the **SQL** knob clockwise until the random noise disappears and the "**BUSY**" icon is turned off. This state is known as the "squelch threshold."
6. Press the  key to select the desired channel. Refer to section "**17 CHANNEL ASSIGNMENTS**" for available channels.
7. When a message is received, adjust the volume to the desired listening level. The "**BUSY**" indicator on the display indicates communications is being received or the radio is unsquelched.

8.2 TRANSMISSION

1. Perform steps 1 through 6 of RECEPTION.
2. Before transmitting, monitor the channel to ensure it is clear.
THIS IS AN FCC REQUIREMENT!
3. Press the **PTT** (push-to-talk) switch. The "**TX**" indicator on the LCD is displayed.
4. Speak slowly and clearly into the microphone.
5. When the transmission is finished, release the **PTT** switch.

NOTE

This is a noise-canceling microphone. Position the oval slot labeled "**MIC**" within 1/2 inch (1.3 cm) from the mouth for optimum performance.

8.3 TRANSMIT TIME - OUT TIMER (TOT)

When the **PTT** switch on the microphone is held down, transmit time is limited to 5 minutes. This limits unintentional transmissions due to a stuck **PTT** switch inside the microphone. About 10 seconds before automatic transmitter shutdown, a warning beep will be heard from the speaker(s). The transceiver will automatically go to receive mode, even if the **PTT** switch is continually held down. Before transmitting again, the **PTT** switch must first be released and then pressed again.

8.4 SIMPLEX/DUPLEX CHANNEL USE

Refer to section “17 CHANNEL ASSIGNMENTS” for instructions on use of simplex and duplex channels.

NOTE

All channels are factory-programmed in accordance with FCC (USA), Industry Canada, and International regulations. Mode of operation cannot be altered from simplex to duplex or vice-versa.

8.5 DISPLAY TYPE

The **GX1600** and **GX1700** display can be setup to show displays other than the default “NORMAL” display by using the procedure below:

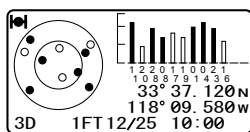
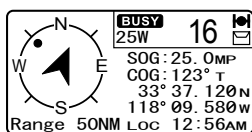
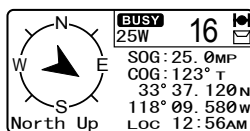
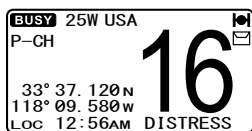

1. Press and hold the **CALL MENU** key until “Setup Menu” appears, then select “GENERAL SETUP” with the **▲/▼** key.
2. Press the **SELECT** soft key, then press the **▲** / **▼** key to select “DISPLAY”.
3. Press the **SELECT** soft key.
4. Press the **▲/▼** key to select desired screen “NORMAL”, “COMPASS”, “WAYPOINT” or “GPS STATUS”.
5. Press the **ENT** soft key to store the selected setting.

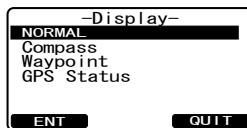
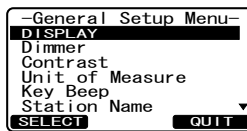
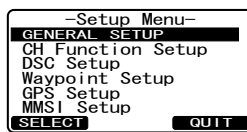





NOTE

When the “GPS STATUS” mode is selected in step 4 above, the display will show the GPS status until a key is pressed.

8.6 USA, CANADA, AND INTERNATIONAL MODE

To change the channel group from USA to Canada or International:

1. Press and hold the  key until "Setup Menu" appears.
2. Press the  key to select "CH FUNCTION SETUP".
3. Press the **SELECT** soft key, then press the  key to select "CH GROUP".
4. Press the **SELECT** soft key.
5. Press the  key to select desired channel group "USA", "INTL", or "CAN".
6. Press the **ENT** soft key to store the selected setting.
7. Press the **QUIT** soft key twice to return to radio operation.

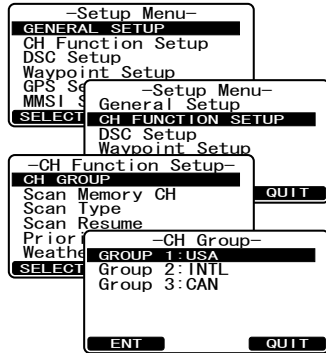

8.7 NOAA WEATHER CHANNELS

1. To receive a NOAA weather channel, press one of the soft keys momentarily, then press the **WX** soft key from any channel. The transceiver will go to the last selected weather channel and the "WX" icon appears on the display.
2. Press the  key to select a different NOAA weather channel.
3. To exit from the NOAA weather channels, press one of the soft keys momentarily, then press the **WX** soft key. The transceiver returns to the channel it was on prior to a weather channel and the "WX" icon disappears on the display.

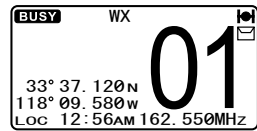

8.7.1 NOAA Weather Alert

In the event of extreme weather disturbances, such as storms and hurricanes, the NOAA (National Oceanic and Atmospheric Administration) sends a weather alert accompanied by a 1050 Hz tone and subsequent weather report on one of the NOAA weather channels.

The **GX1600** and **GX1700** can receive weather alerts when on a weather channel and on the last selected weather channel during scanning modes or while on another channel.

When an alert is received on a NOAA weather channel, scanning will stop and the transceiver will emit a loud beep to alert the user of a NOAA broadcast. Press any key to stop the alert and receive the weather-

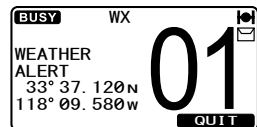

er report. Press the **QUIT** soft key to return to the last selected channel.

To disable the weather alert function, refer to section “**11.6 WEATHER ALERT**”.

NOTE

- If a key is not pressed the alert will sound for 5 minutes and then the weather report will be received.
- While listening to a weather channel, the radio can decode a weather alert and sound an alarm.

8.7.2 NOAA Weather Alert Testing

NOAA tests the alert system ever Wednesday between 11AM and 1PM. To test the NOAA weather feature of the **GX1600** and **GX1700**, on Wednesday between 11AM and 1PM, setup as in section “**8.7.1 NOAA Weather Alert**” and confirm the alert is heard.

8.8 DUAL WATCH (TO CHANNEL 16)

Dual watch is used to scan two channels for communications. One channel is a normal VHF channel and the other is the priority, Channel 16. When a signal is received on the normal channel the radio briefly switches between the normal channel and Channel 16 to look for a transmission. If the radio receives communications on Channel 16 the radio stops and listens to Channel 16 until communication ends and then starts dual watch scan again.

1. Adjust the **SQL** knob until the background noise disappears.
2. Select the channel you wish to dual watch to the priority Channel 16.
3. Press one of the soft keys, then press the **DW** soft key.

The display show “DW-16” and will scan between CH16 and the channel that was selected in step 2. If a transmission is received on the channel selected in step 2, the **GX1600** and **GX1700** will dual watch to CH16.

4. To stop dual watch, press the one of the soft keys, then press the **DW** soft key again.



NOTE

The priority channel may be changed from CH16 to another channel. Refer to section “**11.5 PRIORITY CHANNEL**”.

8.9 SCANNING

Allows you to select the scan type from memory scan or priority scan. “Memory scan” scans the channels that were programmed into memory. “Priority scan” scans the channels programmed in memory with the priority channel.

8.9.1 Scan Type Selection

1. Press and hold the **CALL MENU** key until “Setup Menu” appears.
2. Press the **▲/▼** key to select “CH FUNCTION SETUP”.
3. Press the **SELECT** soft key, then press the **▲/▼** key to select “SCAN TYPE”.
4. Press the **SELECT** soft key.
5. Press the **▲/▼** key to select “PRIORITY SCAN” or “MEMORY SCAN”.
6. Press the **ENT** soft key to store the selected setting.
7. Press the **QUIT** soft key twice to return to radio operation.

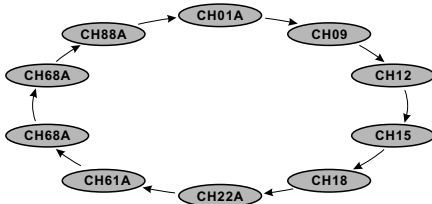
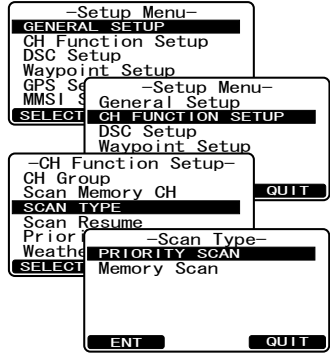

MEMORY SCAN (M-SCAN)

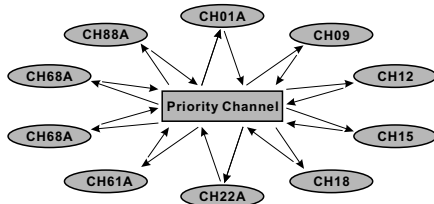



PRIORITY SCAN (P-SCAN)

8.9.2 Scan and P-Scan Memory Programming

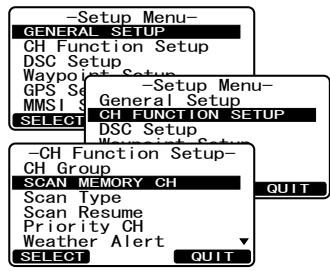
1. Press and hold the **CALL MENU** key until “Setup Menu” appears.
2. Press the **▲/▼** key to select “CH FUNCTION SETUP”.
3. Press the **SELECT** soft key, then press the **▲/▼** key to select “SCAN MEMORY CH”.
4. Press the **SELECT** soft key.



- Press the / key to select a desired channel to be scanned, then press the **ADD** soft key. “MEM” icon appears on the display, which indicates the channel has been selected to the scan channel.

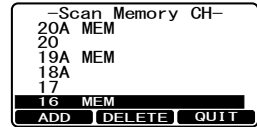

- Repeat step 5 for all the desired channels to be scanned.
- To DELETE a channel from the list, select the channel then press the **DELETE** soft key. “MEM” icon disappears from the display.
- Press the **QUIT** soft key three times to return to radio operation.

8.9.3 Memory Scanning (M-SCAN)

- Adjust the **SQL** knob until the background noise disappears.
- Press one of the soft keys, then press the **SCAN** soft key. “M-SCAN” appears on the display. Scanning will proceed from the lowest to the highest programmed channel number and preset channel (described in the next chapter) and will stop on a channel when a transmission is received.
- The channel number will blink during reception.
- To stop scanning, press the  key or the **SCAN** soft key.

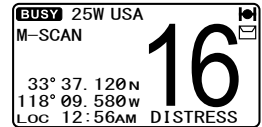



8.9.4 Priority Scanning (P-SCAN)

By default, Channel 16 is set as the priority channel. You may change the priority channel to the desired channel from Channel 16 by the General Setup mode, refer to section “**11.5 PRIORITY CHANNEL**”.

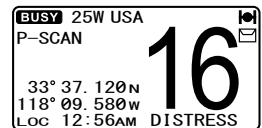



- Adjust the **SQL** knob until the background noise disappears.
- Press one of the soft keys, then press the **SCAN** soft key. “P-SCAN” appears on the display. Scanning will proceed from the lowest to the highest programmed channel number and preset channel (described in the next chapter) and will stop on a channel when a transmission is received.
- To stop scanning, press the  key or press one of the soft keys, then press the **SCAN** soft key.



8.10 PRESET CHANNELS (0 ~ 9): INSTANT ACCESS



10 preset channels can be programmed for instant access. Pressing the  key activates the preset channel bank. If the  key is pressed and no channels have been assigned, an alert beep will be emitted from the speaker.

8.10.1 Preset Channel Programming

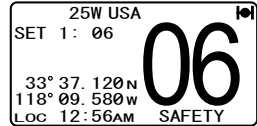
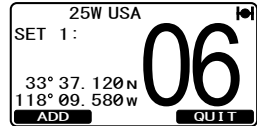
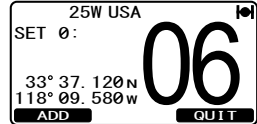
1. Press the  key to select the channel to be programmed.
2. Press and hold the  key until the channel number is blinking.
3. Press the  key to select the desired preset channel position ("SET 0" - "SET 9") you wish to program.
4. Press the  soft key to program the channel into the preset channel.
5. Repeat steps 1 through 4 to program the desired channels into preset channels "0" ~ "9".





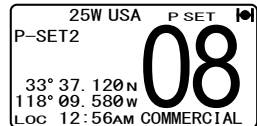
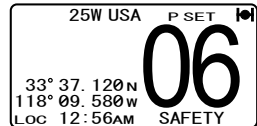

8.10.2 Operation

1. Press the  key to recall the preset channel. The "P SET" icon will appear on the display.
2. Press the  key to select the desired preset channel ("0" ~ "9"). The preset channel number appears ("P-SET0" - "P-SET9") while selecting the preset channel.
3. Press the  key again to return to the last selected channel. The "P SET" icon will disappear from the display.



8.10.3 Deleting a Preset Channel

1. Press the  key.
2. Press the  key to select the preset channel to be deleted.
3. Press and hold the  key until the channel number is blinking.
4. Press the  soft key to delete the channel from the preset channel.
5. Repeat steps 2 through 4 to delete the desired channels from preset channels "0" ~ "9".
6. To finish deleting the preset channel, press the  soft key.

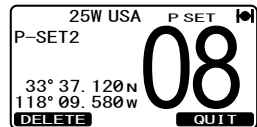
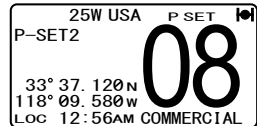

8.11 INTERCOM OPERATION

An optional **RAM3+ (CMP31)** must be connected to perform intercom functions between the radio and the **RAM3+ (CMP31)**.

In addition, to access the following intercom functions one of the soft keys must be setup as **IC**. Refer to section “**10.8 SOFT KEYS**”.

8.11.1 Communication

1. Press one of the soft keys, then press the **IC** soft key to enable the intercom mode.

Note: Depending on the programming of the **IC** soft key, the **NEXT** soft key may have to be pressed to see the **IC** soft key.

2. When the intercom mode is enabled, “Intercom” is displayed on the radio and **RAM3+ (CMP31)** Remote Station Microphone.

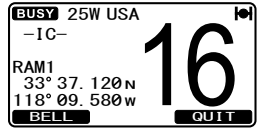

3. Press the **PTT** switch on the radio. “Talk” will be shown on the display.

Note: A warning beep will be heard if the **PTT** button on the **GX1600** or **GX1700** and **RAM3+ (CMP31)** microphone are pushed simultaneously.

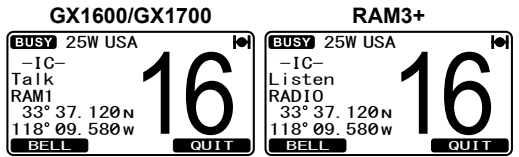

(GX1600/GX1700's PTT switch is pressed)

4. Speak slowly and clearly into the microphone, hold the microphone about 1/2 inch away from your mouth.

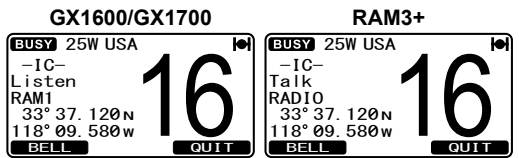

(RAM3+'s PTT switch is pressed)

5. When finished, release the **PTT** switch.
6. Press the **QUIT** soft key to exit intercom mode and revert to radio mode.

8.11.2 Calling

Pressing the **BELL** soft key when in the intercom mode on either the radio or **RAM3+ (CMP31)** microphone will produce a calling beep to the other station.

9 DIGITAL SELECTIVE CALLING

9.1 GENERAL

WARNING

The **GX1600** and **GX1700** are designed to generate digital maritime distress and safety calls to facilitate search and rescue. To be effective as a safety device, this equipment must be used only within communication range of a shore-based VHF marine channel 70 distress and safety watch system. The range of signal may vary, however under normal conditions should be approximately 20 nautical miles.

Digital Selective Calling is a semi-automated method of establishing a radio call, it has been designated by the International Maritime Organization (IMO) as an international standard for establishing VHF, MF and HF radio calls. It has also been designated as part of the Global Maritime Distress and Safety System (GMDSS).

Digital Selective Calling allows mariners to instantly send a distress call with GPS position (when connected to the transceiver) to the US Coast Guard and other vessels within range of the transmission. DSC will also allow mariners to initiate or receive Distress, Urgency, Safety, Routine, Position Request, Position Report, Automatic Position Polling and Group calls to or from another vessel equipped with a DSC transceiver.

NOTE

A DSC Warning sticker is included with the **GX1600** and **GX1700**. To comply with FCC regulations this sticker must be mounted in a location that can be easily viewed from the location of the **GX1600** and **GX1700**.

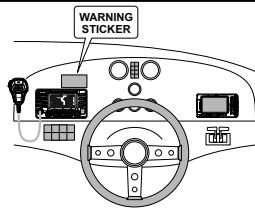

9.2 MARITIME MOBILE SERVICE IDENTITY (MMSI)

9.2.1 What is an MMSI?

An MMSI is a nine digit number used on marine transceivers capable of using Digital Selective Calling (DSC). This number is used like a telephone number to selectively call other vessels.

THIS NUMBER MUST BE PROGRAMMED INTO THE RADIO TO OPERATE DSC FUNCTIONS.

How can I obtain an MMSI assignment?

In the USA, visit the following websites to register:

<http://www.boatus.com/mmsi/>

http://seatow.com/boating_safety/mmsi.asp

<http://www.usps.org/php/mmsi/rules.php>

In the Canada, visit

<http://www.ic.gc.ca/epic/site/smt-gst.nsf/en/sf01032e.html>

9.2.2 Programming the MMSI

WARNING

The MMSI can be inputted only once. Therefore please be careful not to input an incorrect MMSI number. If you need to change the MMSI number after it has been entered, the radio will have to be returned to Factory Service. Refer to the section “16.2 FACTORY SERVICE.”

1. Press and hold the **CALL MENU** key until “Setup Menu” appears.
2. Press the **▲/▼** key to select “MMSI SETUP”.
3. Press the **SELECT** soft key. (To cancel, press the **QUIT** soft key.)
4. Press the **▲/▼** key to select the first number of your MMSI, then press the **ENT** soft key to step to the next number.
5. Repeat step 4 to set your MMSI number (nine digits).
6. If a mistake was made entering in the MMSI number, press the **BACK** soft key until the wrong digit is selected, then press the **▲/▼** key to correct the entry and press the **ENT** soft key.
7. When finished programming the MMSI number, press and hold the **ENT** soft key. The radio will ask you to input the MMSI number again. Use steps 4 through 6 above.
8. After the second number has been input, press and hold the **ENT** soft to store the MMSI.
9. Press the **OK** soft key to return to the setup menu.
10. Press the **QUIT** soft key to return to radio operation.

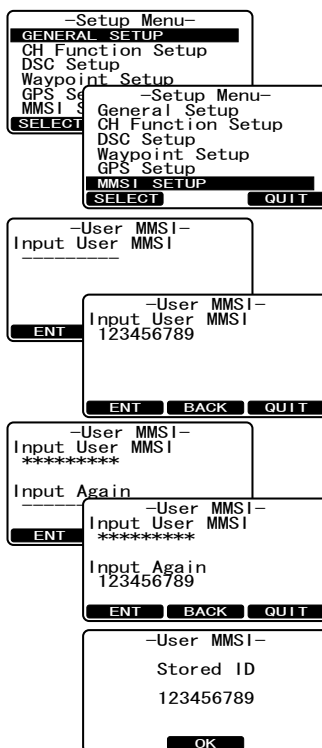

NOTE

To view your MMSI after programming to ensure it is correct, perform steps 1 through 3. Look that the MMSI number shown on the display is correct.

9.3 DSC DISTRESS ALERT

The **GX1600** connected to a GPS with NMEA0183 output and **GX1700** are capable of transmitting and receiving DSC distress messages with your vessels position. See also the section “**6.5 ACCESSORY CABLE.**”

9.3.1 Transmitting a DSC Distress Alert

NOTE

- To be able to transmit a DSC distress alert an MMSI number must be programmed (refer to section “**9.2.2 Programming the MMSI**”).
- For the **GX1600**, in order for your ship’s location to be transmitted a GPS must be connected. Refer to the section “**6.5 ACCESSORY CABLE.**”
- For the **GX1700** to be able to transmit a DSC distress call with your ship’s location, the internal GPS must be able to receive a fix or a optional GPS antenna or chart plotter must be connected. Refer to the section “**6.5 ACCESSORY CABLE.**”

9.3.1.1 Basic Operation

1. Lift the red spring loaded DISTRESS cover, and press and hold the  key. The “DISTRESS ALERT” menu will appear on the display. The radio will count down (3-2-1) and then transmit the distress alert. The backlight of the display and keypad flashes while the radios display is counting down.
2. When the distress signal is sent, the transceiver watches for a transmission between CH16 and CH70 until an acknowledgment signal is received.
3. If no acknowledgment is received, the distress call is repeated in 4 minute intervals until a DSC acknowledgment is received.

```
!DISTRESS ALERT!  
Nature of:Undesignated  
Position: 33° 37. 120N  
          118° 09. 580W  
POS Time: 10:00  
  
Time for 3 sec
```

```
!DISTRESS ALERT!  
Nature of:Undesignated  
Position: 33° 37. 120N  
          118° 09. 580W  
POS Time: 10:00  
  
Transmitting
```

```
!DISTRESS ALERT!  
Nature of:Undesignated  
Position: 33° 37. 120N  
          118° 09. 580W  
POS Time: 10:00  
TX In: 02:25  
Wait for ACK  
[PAUSE] [CANCEL]
```

- When a DSC distress acknowledgment is received, a distress alarm sounds and channel 16 is automatically selected. The display shows the MMSI of the ship responding to your distress.

RECEIVED ACK: acknowledgment signal is received.

RECEIVED RLY: relay signal is received from another vessel or coast station.

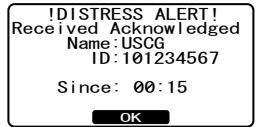

- Press the **PTT** button and state your name, vessel name, number of persons on board and the distress situation, then say over and wait for a reply from the acknowledging ship.
- To momentarily turn off the distress alarm until the radio retransmits the distress call, press the **16/9** key.

9.3.1.2 Transmitting a DSC Distress Alert with Nature of Distress

The **GX1600** and **GX1700** are capable of transmitting a DSC distress alert with the following “Nature of Distress” categories you may have:

Undesignated, Fire, Flooding, Collision, Grounding, Capsizing, Sinking, Adrift, Abandoning, Piracy, MOB

- Press the **CALL MENU** key. The “DSC Menu” will appear.
- Press the **▲/▼** key to select “DISTRESS ALERT MSG”.
- Press the **SELECT** soft key. (To cancel, press the **QUIT** soft key.) The “DISTRESS ALERT MSG” menu will appear on the display.
- Press the **NATURE** soft key, then press the **▲/▼** key to select the desired nature of distress category.

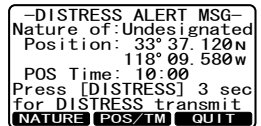

Nature of distress categories: Fire, Flood, Collision, Grounding, Capsizing, Sinking, Adrift, Abandoning, Piracy, and MOB.

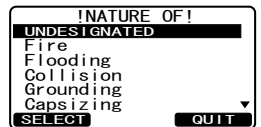

- Press the **SELECT** soft key.
- Press and hold the **DISTRESS** key until a distress alert is transmitted.
- Perform the steps 1 through 6 of the basic operation described in the previous section.

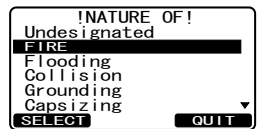

9.3.1.3 Transmitting a DSC Distress Alert by Manually Entering a Position

The **GX1600** and **GX1700** allow you to manually enter a latitude/Longitude of your vessel to be able to transmit a DSC distress alert.

1. Press the **CALL MENU** key. The “DSC Menu” will appear.
2. Press the **▲/▼** key to select “DISTRESS ALERT MSG”.
3. Press the **SELECT** soft key. (To cancel, press the **QUIT** soft key.) The “DISTRESS ALERT MSG” menu will appear on the display.
4. Press the **POS/TM** soft key.
5. Enter UTC time in the 24-hour format and the latitude and longitude of your vessel. Press the **▲/▼** key to select the number and press the **ENT** soft key to move the cursor to the next character. You may backspace the cursor by pressing the **BACK** soft key if you make a mistake.
6. When you have completed your selection, press and hold in the **ENT** soft key for two seconds to save the setting.
7. Press and hold the **DISTRESS** key until a distress alert is transmitted.
8. Perform the steps 1 through 6 of the basic operation described in the previous section.

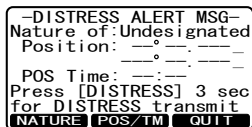

-DISTRESS ALERT MSG-
Nature of: Undesignated
Position: ___° ___' ___"
POS Time: ___:___:___
Press [DISTRESS] 3 sec
for DISTRESS transmit
NATURE POS/TM QUIT

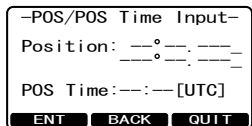

-POS/POS Time Input-
Position: ___° ___' ___"
POS Time: ___:___[UTC]
ENT BACK QUIT

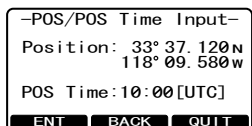

-POS/POS Time Input-
Position: 33° 37.120N
118° 09.580W
POS Time: 10:00[UTC]
ENT BACK QUIT

9.3.1.4 Pausing a DSC Distress Call

After a DSC distress call is transmitted, the call is repeated every 4 minutes until the call is canceled by the user or until the radio is turned on and off again. The **GX1600** and **GX1700** have provision to suspend (pause) the retransmitting of the distress call by the procedure below.

1. After the distress call is transmitted, the radio will show the top display to the right.
Looking at this display you will notice “TX in: 02:25” that is the time when the radio will re-transmit the DSC distress call.
2. To suspend re-transmitting the DSC distress call, press the **PAUSE** soft key.
3. To resume counting down to transmit the DSC distress call, press the **RESUME** soft key.

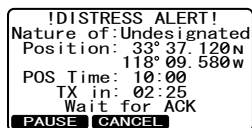

!DISTRESS ALERT!
Nature of: Undesignated
Position: 33° 37.120N
118° 09.580W
POS Time: 10:00
TX in: 02:25
Wait for ACK
PAUSE CANCEL

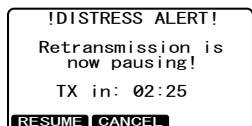

!DISTRESS ALERT!
Retransmission is
now pausing!
TX in: 02:25
RESUME CANCEL

9.3.1.5 Canceling a DSC Distress Call

If a DSC distress call was sent by error the **GX1600** and **GX1700** allow you to send a message to other vessels to cancel the distress call that was made.

Press the **CANCEL** soft key, then press **YES** soft key.

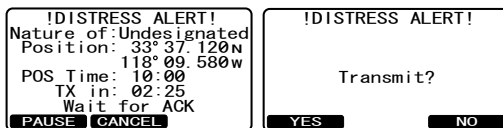

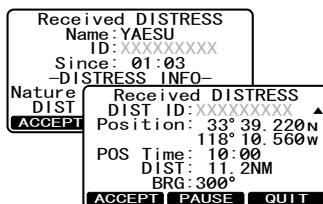

9.3.2 Receiving a DSC Distress Call

1. When a DSC distress call is received, an emergency alarm sounds.
2. Press any key to stop the alarm.
3. The display shows the position of the vessel in distress. To show additional information of the vessel in distress, press the  key (refer to the second display).



On the display you will notice 3 soft key selections. These selections are described below:

- a. **ACCEPT**: Press to immediately select Channel 16.
Note: If a key is not pressed for 30 seconds (by default; refer to the section “**12.9 AUTO CHANNEL SWITCH TIME**”) or longer the radio will automatically select Channel 16.
 - b. **PAUSE**: Temporarily suspend switching to Channel 16.
 - c. **QUIT**: Exit to the working channel.
4. Press the **WPT** soft key to enter the “Waypoint Input” menu, then enter the desired waypoint name (up to 11 characters), described previously (select the letter/number by pressing the / key and move the cursor by pressing the **ENT** / **BACK** soft key).

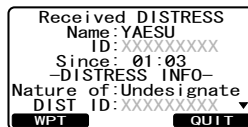

5. The ID is the MMSI from the vessel in distress.
6. When you are finished entering the waypoint name, press and hold the **ENT** soft key to replace the display to the “WAYPOINT” screen. The display indicates the distance and direction of the vessel in distress by a dot (●).
7. To stop navigating to a waypoint, press one of the soft keys, then press the **STOP** soft key. The radio is switched to the normal mode.

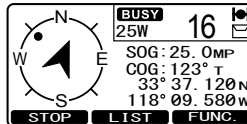
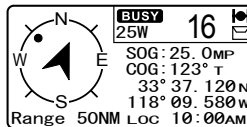
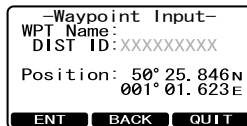

NOTE

You must continue monitoring Channel 16 as a coast station may require assistance in the rescue attempt.

NOTE

When there is an unread distress alert, “✉” icon will appear on the display. You may review the unread distress alert from the DSC log, refer to the section “**9.13.2 Reviewing DSC Distress Logged Calls.**”

9.4 ALL SHIPS CALL

The all ships call function allows contact to be established with DSC equipped vessels without having their MMSI in the individual calling directory. Also, priority for the call can be designated as “Urgency” or “Safety”.

URGENCY Call: This type of call is used when a vessel may not truly be in distress, but has a potential problem that may lead to a distress situation. This call is the same as saying “PAN PAN, PAN PAN, PAN PAN” on Channel 16.

SAFETY Call: This type of call is used to transmit boating safety information to other vessels. This message usually contains information about an overdue boat, debris in the water, loss of a navigation aid or an important meteorological message. This call is the same as saying “Securite, Securite, Securite.”

9.4.1 Transmitting an All Ships Call

1. Press the **CALL MENU** key. The “DSC Menu” will appear.
2. Press the **▲/▼** key to select “ALL SHIPS”.
3. Press the **SELECT** soft key. (To cancel, press the **QUIT** soft key.)
4. Press the **▲/▼** key to select the nature of call (“SAFETY” or “URGENCY”), then press the **SELECT** soft key.
5. Press the **▲/▼** key to select the operating channel you want to communicate on, then press the **SELECT** soft key.
6. Press the **YES** soft key to transmit the selected type of all ships DSC call.
7. After the all ships call is transmitted, the transceiver will switch to the selected channel.
8. Listen to the channel to make sure it is not busy, then press the microphone’s **PTT** switch and say “PAN PAN, PAN PAN, PAN PAN” or “Securite, Securite, Securite” depending on the priority of the call and state your message.
9. Press the **QUIT** soft key to exit the all ships call menu.

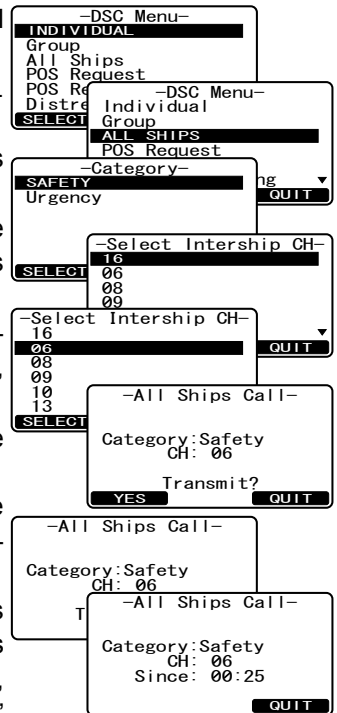

9.4.2 Receiving an All Ships Call

1. When an all ships call is received, an emergency alarm will sound.

The display shows the MMSI of the vessel transmitting the all ships call and the radio will change to the requested channel after 10 seconds.

2. Press any key to stop the alarm.
3. Monitor the requested channel until the all ships voice communication is completed.

On the display you will notice 3 soft key selections. These selections are described below:

- a. **ACCEPT**: Accept to auto switching to Channel 16.

Note: If a key is not pressed for 30 seconds or longer the radio will automatically select Channel 16.

- b. **PAUSE**: Temporarily suspend switching to Channel 16.
- c. **QUIT**: Exit to the working channel.

4. Press the **QUIT** soft key to return to the channel display.

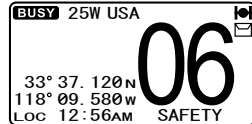

NOTE

When there is an unread all ships call, “” icon will appear on the display. You may review the unread all ships call from the DSC log, refer to the section “**9.13.3 Reviewing Other Logged Calls.**”













9.5 INDIVIDUAL CALL

This feature allows the **GX1600** and **GX1700** to contact another vessel with a DSC VHF radio and automatically switch the receiving radio to a desired communications channel. This feature is similar to calling a vessel on CH16 and requesting to go to another channel (switching to the channel is private between the two stations). Up to 80 Individual contacts may be programmed.



9.5.1 Setting up the Individual / Position Call Directory

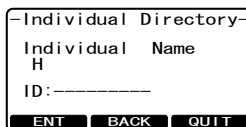
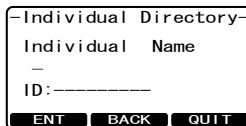
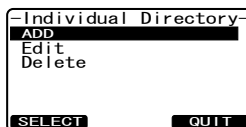
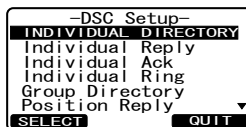
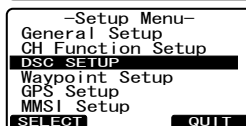
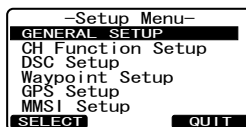

The **GX1600** and **GX1700** have a DSC directory that allows you to store a vessel's or person's name and the MMSI number associated with vessels you wish to transmit individual calls, auto polling calls, position requests, and position reports.

To transmit an individual call you must program this directory with information of the persons you wish to call, similar to a cellular phones telephone directory.

1. Press and hold the  key until "Setup Menu" appears.
2. Press the  key to select "DSC SETUP" menu.
3. Press the  soft key, then select "INDIVIDUAL DIRECTORY" with the  key.
4. Press the  soft key.
5. Select "ADD" with the  key, then press the  soft key.
6. Press the  key to scroll through the first letter of the name of the vessel or person you want to reference in the directory.
7. Press the  soft key to store the first letter in the name and step to the next letter to the right.
8. Repeat step 6 and 7 until the name is complete. The name can consist of up to eleven characters, if you do not use all eleven characters press the  soft key to move to the next space. This method can also be used to enter a blank space in the name. If a mistake was made entering in the name repeat pressing the  soft key until the wrong character is selected, then press the  key to correct the entry.









9. After the eleventh letter or space has been entered, press and hold the **ENT** soft key to advance to the MMSI (Maritime Mobile Service Identity Number) number entry.
10. Press the / key to scroll through numbers, 0-9. To enter the desired number and move one space to the right by pressing the **ENT** soft key. Repeat this procedure until all nine space of the MMSI number are entered.

-Individual Directory-
 Individual Name
 Horizon
 ID: _____
ENT **BACK** **QUIT**
11. If a mistake was made entering in the MMSI number repeat pressing the **BACK** soft key until the wrong digit is selected, then press the / key to correct the entry.
12. To store the data entered, press and hold the **ENT** soft key.

-Individual Directory-
 Individual Name
 Horizon
 ID: 123456789
ENT **BACK** **QUIT**
13. To enter another individual address, repeat steps 5 through 12.
14. Press the **QUIT** soft key three times to return to radio operation.

9.5.2 Setting up the Individual Call Reply

This menu item sets up the radio to automatically (default setting) or manually respond to a DSC individual call requesting you to switch to a working channel for voice communications. When “Manual” is selected the MMSI of the calling vessel is shown allowing you to see who is calling. This function is similar to caller ID on a cellular phone.



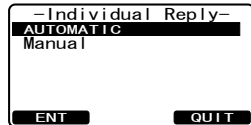
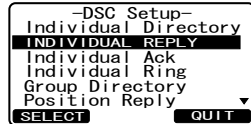
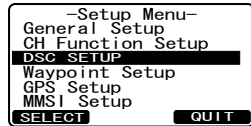
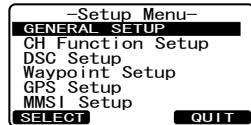

1. Press and hold the  key until “Setup Menu” appears.
2. Press the / key to select “DSC SETUP” menu.
3. Press the **SELECT** soft key, then select “INDIVIDUAL REPLY” with the / key.
4. Press the **SELECT** soft key.
5. Press the / key to select “AUTOMATIC” or “MANUAL”.
6. Press the **ENT** soft key to store the selected setting.
7. Press the **QUIT** soft key twice to return to radio operation.



9.5.3 Setting up the Individual Call Acknowledgment

The **GX1600** and **GX1700** can select either reply message “Able” (default) or “Unable” when the individual reply setting (described in the previous section) is set to “AUTOMATIC”.

When the individual reply setting (described in the previous section) is set to “AUTOMATIC”, the **GX1600** and **GX1700** can be setup to reply “Able” (default) or “Unable” to a received individual call. When “Unable” is selected the **GX1600** and **GX1700** will transmit an “Unable” reply to the calling station to inform them you are away from your radio.

1. Press and hold the  key until “Setup Menu” appears.
2. Press the  key to select “DSC SETUP” menu.
3. Press the **SELECT** soft key, then select “INDIVIDUAL ACK” with the  key.
4. Press the **SELECT** soft key.
5. Press the  key to select “ABLE TO COMPLY” or “UNABLE”.
6. Press the **ENT** soft key to store the selected setting, then press the **QUIT** soft key twice to return to radio operation.

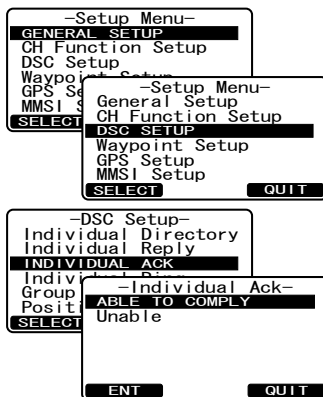

9.5.4 Transmitting an Individual Call

This feature allows you to contact another vessel with a DSC radio. This feature is similar to calling a vessel on CH16 and requesting to go to another channel.

9.5.4.1 Individual Call using the Individual/Position Call Directory

1. Press the **CALL MENU** key. The “DSC Menu” will appear.
2. Press the **▲/▼** key to select “INDIVIDUAL”. (To cancel, press the **QUIT** soft key.)
3. Press the **SELECT** soft key. The “Individual Call” menu will appear. The previous six individual contacts will be listed.
4. Press the **▲/▼** key to select an individual you want to contact.

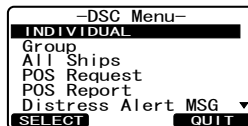

- Press the **NEW ID** soft key to select an individual other than those on the display.

5. Press the **SELECT** soft key, then press the **▲/▼** key to select the operating channel you want to communicate on, then press the **SELECT** soft key.
6. Press the **YES** soft key to transmit the individual DSC signal.
7. When an individual call acknowledgment is received, the established channel is automatically changed to the channel selected in step 5 above and a ringing tone sounds.
8. Press the **QUIT** soft key to listen to the channel to make sure it is not busy, then press the microphone's **PTT** switch and talk into the microphone to the other vessel.

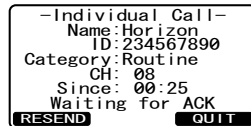
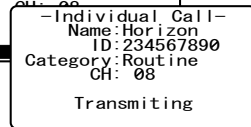
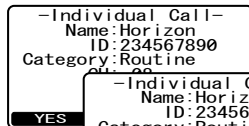
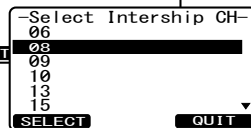
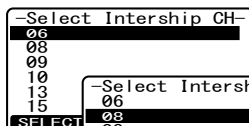

9.5.4.2 Individual Call by Manually Entering a MMSI

You may enter an MMSI number manually to contact a vessel without storing the MMSI in the individual/position call directory.

1. Press the **CALL MENU** key. The “DSC Menu” will appear.
2. Confirm “INDIVIDUAL” is selected. (To cancel, press the **QUIT** soft key.)
3. Press the **SELECT** soft key. The “Individual Call” menu will appear. The previous six individual contacts will be listed.
Press the **NEW ID** soft key.
4. Confirm “MANUAL” is selected, then press the **SELECT** soft key.
5. Press the **▲/▼** key to select the first number of the MMSI which you want to contact, then press the **SELECT** soft key to step to the next digit.
6. Repeat step 5 to set the MMSI number (nine digits).
7. If a mistake was made entering in the MMSI number, repeat pressing the **BACK** soft key until the wrong digit is selected, then press the **▲/▼** key to correct the entry.
8. When finished entering the MMSI number, press and hold the **SELECT** soft key.
9. Press the **▲/▼** key to select the operating channel you want to communicate on, then press the **SELECT** soft key.

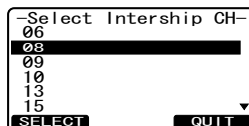
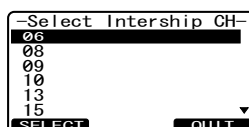
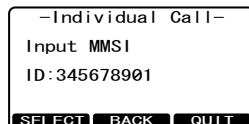
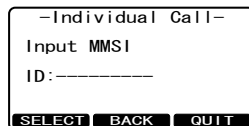
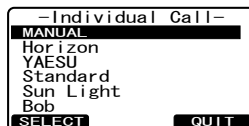
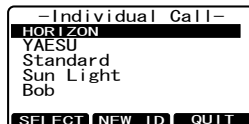
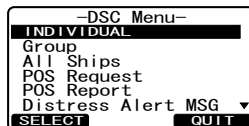

10. Press the **YES** soft key to transmit the individual DSC signal.
11. When an individual call acknowledgment is received, the established channel is automatically changed to the channel which is selected on step 5 above and a ringing tone sounds.
12. Press the **QUIT** soft key to listen to the channel to make sure it is not busy, then press the microphone's **PTT** switch and talk into the microphone to the other vessel.

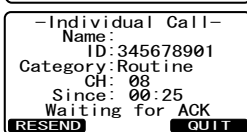
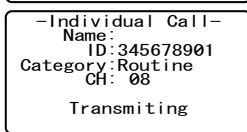
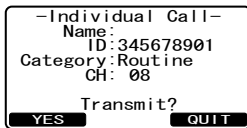

9.5.5 Receiving an Individual Call

When an individual DSC call is received, the radio will automatically respond (Default setting) to the calling ship, and switch to the requested channel for voice communications. Refer to section “9.5.2 Individual Reply Setup” to change the reply to “Manual” if you want to see who is calling before replying to the call.

Automatic reply:

1. When an individual call is received, an individual call ringing alarm sounds.
The radio automatically switches to the requested channel. The display shows the MMSI of the vessel calling.
2. Press any key to stop the alarm.
3. Press the **QUIT** soft key to return to radio operation.
4. Press the microphone's **PTT** switch and talk into the microphone to the other vessel.



Manual reply:

1. When an individual call is received, an individual call ringing alarm sounds.
The display shows the MMSI of the vessel calling.
 2. Press any key to stop the alarm.
 3. Monitor the channel for the person calling the group for a message.
On the display you will notice 3 soft key selections. These selections are described below:
 - a. **ACCEPT**: Press to immediately select Channel 16.**Note:** If a key is not pressed for 30 seconds or longer the radio will automatically select Channel 16.
 - b. **PAUSE**: Temporarily suspend switching to Channel 16.
 - c. **QUIT**: Exit to the working channel.
4. Press the microphone's **PTT** switch and talk into the microphone to the other vessel.
5. Press the **QUIT** soft key to return to radio operation.

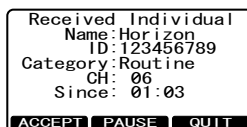

NOTE

When there is an unread individual call, "✉" icon will appear on the display. You may review the unread individual call from the DSC log, refer to the section "9.13.3 Reviewing Other Logged Calls."



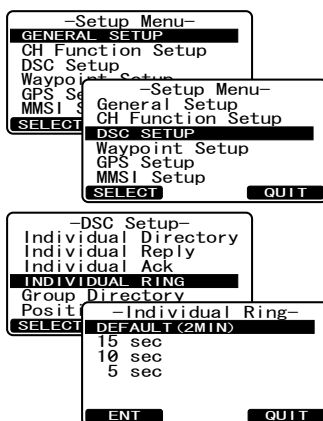

9.5.6 Setting up the Individual Call Ringer

When an individual call is received the radio will produce a ringing sound for 2 minutes. This selection allows the individual call ringer time to be changed.

1. Press and hold the **CALL MENU** key until "Setup Menu" appears.
2. Press the **▲/▼** key to select "DSC SETUP" menu.
3. Press the **SELECT** soft key, then select "INDIVIDUAL RING" with the **▲/▼** key.
4. Press the **SELECT** soft key.
5. Press the **▲/▼** key to select ringing time of an individual call.
6. Press the **ENT** soft key to store the selected setting, then press the **QUIT** soft key twice to return to radio operation.



The **GX1600** and **GX1700** have the capability to turn off the individual ringer.

1. Press and hold the  key until “Setup Menu” appears.
2. Press the  key to select “DSC SETUP” menu.
3. Press the **SELECT** soft key, then select “DSC BEEP” with the  key.
4. Press the **SELECT** soft key.
5. Press the  key to select “Individual”, then press the **ENT** soft key.
6. Press the  key to select “Off”.
7. Press the **ENT** soft key to store the selected setting, then press the **QUIT** soft key three times to return to radio operation.

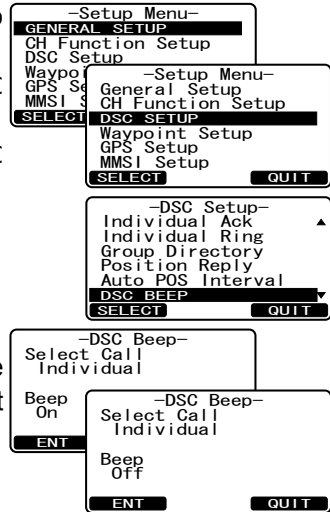

To re-enable the ringer, repeat the above procedure, pressing the  key to select “On” in step 6 above.

NOTE

The **GX1600** and **GX1700** may turn on and off the call ringer of the all ships, position request, and position report calls as well as the individual and group calls.

9.6 GROUP CALL

This feature allows the user to contact a group of specific vessels (example members of a yacht club) using DSC radios with group call function to automatically switch to a desired channel for voice communications. This function is very useful for yacht clubs and vessels traveling together that want to collectively make announcements on a predetermined channel. Up to 32 group MMSI may be programmed.

9.6.1 Setting up the Group Call





For this function to operate, the same group MMSI must be programmed into all the DSC VHF radios within the group of vessels that will be using this feature. To understand group MMSI programming, first a ship MMSI has to be understood.

Ship MMSI: The first three digits called a MID (Mobile Identity Group) of a ship MMSI denote the country the ship registered for a MMSI. The last 6 digits are specific to the ships ID.







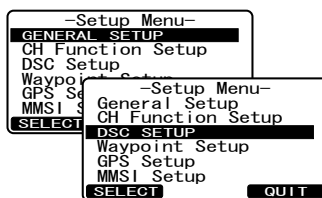

Ship MMSI Example: If your MMSI is “366123456”, “366” is MID which denote the country and “123456” is your ships MMSI.

Group MMSI:

- ❑ Group MMSI numbers are not assigned by the FCC or other organizations licensed to assign ship MMSI numbers.
- ❑ The first digit of a group MMSI is always set to “0” by the international rules. All Standard Horizon radios are preset so when programming a group MMSI the first digit is set to “0”.
- ❑ The USCG recommends programming the MID of a ships MMSI into the second, third and fourth digits of the group MMSI as it denotes the area the ship is located in.
- ❑ The last 5 digits are decided upon by persons in the group. This is an important step as all radios in the group must contain the same group MMSI so they can be contacted by each other. There is a chance that another group of vessels may program in the same group MMSI. If this happens, simply change one or more of the last 5 digits of the group MMSI.

1. Press and hold the  key until “Setup Menu” appears.
2. Press the  key to select “DSC SETUP” menu.
3. Press the **SELECT** soft key, then select “GROUP DIRECTORY” with the  key.
4. Press the **SELECT** soft key, then select “ADD” with the  key.



5. Press the **SELECT** soft key.
6. Press the / key to scroll through the first letter of the name of the group you want to reference in the directory.
7. Press the **SELECT** soft key to store the first letter in the name and step to the next letter to the right.
8. Repeat step 6 and 7 until the name is complete. The name can consist of up to eleven characters, if you do not use all eleven characters press the **ENT** soft key to move to the next space. This method can also be used to enter a blank space in the name. If a mistake was made entering in the name repeat pressing the **BACK** soft key until the wrong character is selected, then press the / key to correct the entry.
9. After the eleventh letter or a space has been entered, press and hold the **ENT** soft key to advance to the group MMSI (Maritime Mobile Service Identity Number) number entry.
10. Press the / key to select the second digit of the MMSI (nine digits: first digit permanently set to "0") which you want to contact, then press the **ENT** soft key to step to the next digit. Repeat this procedure until all eight digits of the MMSI number are entered.
11. If a mistake was made entering in the MMSI number repeat pressing the **BACK** soft key until the wrong digit is selected, then press the / key to correct the entry.
12. To store the data entered, press and hold the **ENT** soft key.
13. To enter another group address, repeat steps 5 through 12.
14. Press the **QUIT** soft key three times to return to radio operation.

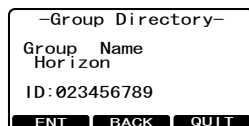
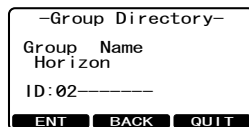
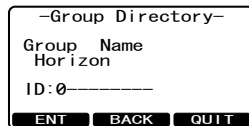
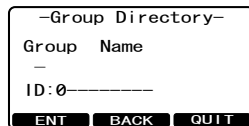
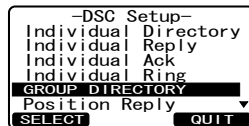

9.6.2 Transmitting a Group Call

9.6.2.1 Group Call using the Group Call Directory

1. Press the **CALL MENU** key. The “DSC Menu” will appear.
2. Press the **▲/▼** key to select “GROUP”. (To cancel, press the **QUIT** key.)
3. Press the **SELECT** soft key. The “Group Call” menu will appear. The previous six group contacts will be listed.
4. Press the **▲/▼** key to select the group you want to contact.
Press the **NEW ID** soft key to select a group other than those on the display.
5. Press the **SELECT** soft key, press the **▲/▼** key to select the operating channel you want to communicate on, then press the **SELECT** soft key.
6. Press the **YES** soft key to transmit the group call signal.
7. When the group call signal is sent, the display will be as shown in the illustration at the right.
8. After the group call is transmitted, all the radios in the group will switch to the designated channel.
9. Listen to the channel to make sure it is not busy, then press the microphone's **PTT** switch and call the other vessel you desire to communicate with.

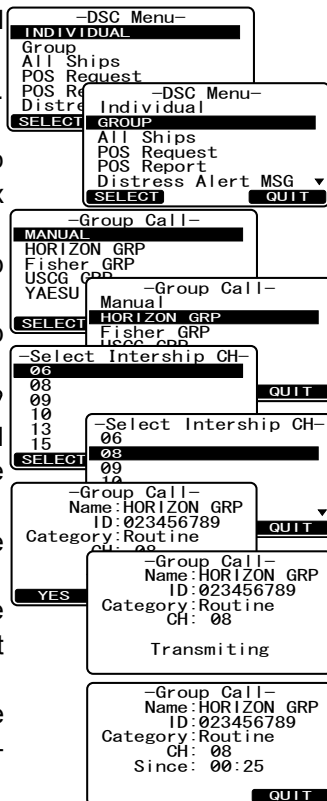

9.6.2.2 Group Call by Manually Entering a MMSI

You may enter an MMSI number manually to contact a vessel without storing the MMSI in the group call directory.

1. Press the **CALL MENU** key. The “DSC Menu” will appear.
2. Press the **▲/▼** key to select “GROUP”. (To cancel, press the **QUIT** soft key.)
3. Press the **SELECT** soft key. The “Group Call” menu will appear. The previous six group contacts will be listed. Press the **NEW ID** soft key.
4. Confirm “MANUAL” is selected and press the **SELECT** soft key.
5. Press the **▲/▼** key to select the second number of the MMSI (nine digits: first digit permanently set to “0”) which you want to contact, then press the **SELECT** soft key to step to the next digit.
6. Repeat step 5 to set the MMSI number.
7. If a mistake was made entering in the MMSI number, repeat pressing the **BACK** soft key until the wrong digit is selected, then press the **▲/▼** key to correct the entry.
8. When finished entering the MMSI number, press and hold the **SELECT** soft key.
9. Press the **▲/▼** key to select the operating channel you want to communicate on, then press the **SELECT** soft key.
10. Press the **YES** soft key to transmit the group call signal.
11. After the group call is transmitted, all the radios in the group will switch to the designated channel.
12. Listen to the channel to make sure it is not busy, then press the microphone’s **PTT** switch and talk into the microphone to the group of vessels.

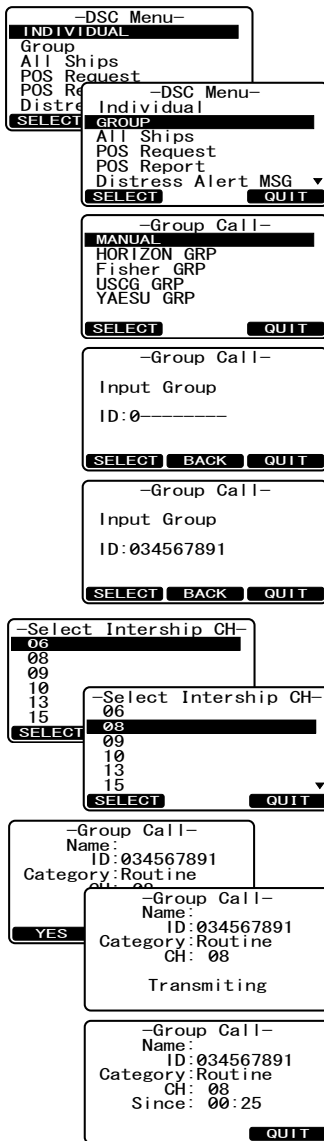

9.6.3 Receiving a Group Call

1. When a group call is received, the **GX1600** and **GX1700** will produce a ringing alarm sound. (DSC BEEP needs to be enabled to hear alarm.)
2. The display shows the group MMSI number.
3. Press any key to stop the alarm.
4. Monitor the channel for the person calling the group for a message. On the display you will notice 3 soft key selections. These selections are described below:
 - a. **ACCEPT**: Press to immediately select Channel 16.

Note: If a key is not pressed for 30 seconds or longer the radio will automatically select Channel 16.

 - b. **PAUSE**: Temporarily suspend switching to Channel 16.
 - c. **QUIT**: Exit to the working channel.
5. If you want to respond, monitor the channel to make sure it is clear, then press the microphone's **PTT** switch and talk into the microphone to the group of vessels.
6. Press the **QUIT** soft key to return to radio operation.

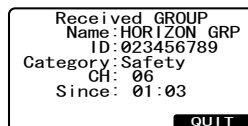
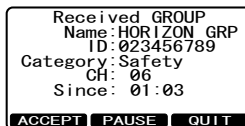





NOTE

When there is an unread group call, “” icon will appear on the display. You may review the unread group call from the DSC log, refer to the section “**9.13.3 Reviewing Other Logged Calls.**”

9.6.4 Setting up the Group Call Ringer

The **GX1600** and **GX1700** have the capability to turn off the group call ringer.

1. Press and hold the  key until “Setup Menu” appears.
2. Press the  key to select “DSC SETUP” menu.
3. Press the **SELECT** soft key, then select “DSC BEEP” with the  key.
4. Press the **SELECT** soft key.
5. Press the  key to select “Group”, then press the **ENT** soft key.
6. Press the  key to select “Off”.
7. Press the **ENT** soft key to store the selected setting, then press the **QUIT** soft key three times to return to radio operation.

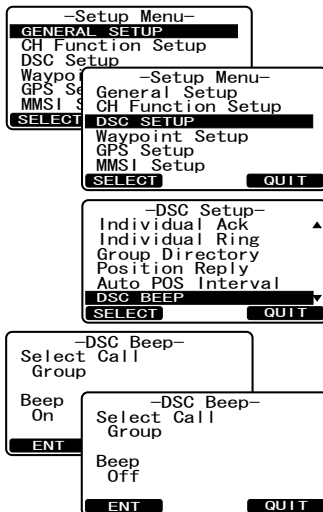

To re-enable the ringer, repeat the above procedure, pressing the  key to select “On” in step 6 above.

NOTE

The **GX1600** and **GX1700** may turn on and off the call ringer of the all ships, position request, and position report calls as well as the individual and group calls.

9.7 POSITION REQUEST







Advancements in DSC have made it possible to poll the location of another vessel and show the position of that vessel on the display of the **GX1600** and **GX1700**. Standard Horizon has taken this feature one step further, if any compatible GPS chart plotter is connected to the **GX1600** and **GX1700**, the polled position of the vessel is shown on the display of the GPS chart plotter making it easy to navigate to the location of the polled vessel. This is a great feature for anyone wanting to know the position of another vessel. For example your buddy that is catching fish, or finding the location of a person you are cruising with.

NOTE

The other vessel must have an operating GPS receiver connected to its DSC radio and must not have its radio set to deny position requests. (Refer the section “**9.5 INDIVIDUAL CALL**” to enter information into the individual directory).

9.7.1 Setting up the Position Reply

The **GX1600** and **GX1700** can be setup to automatically (default setting) or manually send your position when requested by another vessel. This selection is important if you are concerned about someone polling the position of your vessel that you may not want to. In the manual mode you will see the MMSI or persons name shown on the display allowing you to choose to send your position to the requesting vessel.

1. Press and hold the  key until “Setup Menu” appears.
2. Press the  key to select “DSC SETUP” menu.
3. Press the  soft key, then select “POSITION REPLY” with the  key.
4. Press the  soft key, then select “AUTOMATIC” or “MANUAL”. In “AUTOMATIC” mode, after a DSC position request is received, the radio will automatically transmit your position. In “MANUAL” mode, the display of the **GX1600** and **GX1700** will show who is requesting the position and the  soft key on the radio has to be pressed to send your position to the requesting vessel.

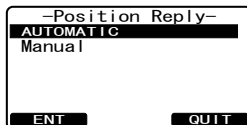
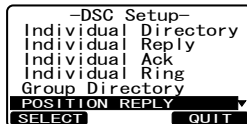
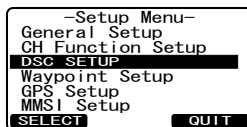
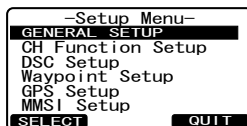

5. Press the **ENT** soft key to store the selected setting.
6. Press the **QUIT** soft key twice to return to radio operation.

9.7.2 Transmitting a Position Request to Another Vessel

9.7.2.1 Position Request using the Individual/Position Call Directory

1. Press the **CALL MENU** key. The “DSC Menu” will appear.
2. Press the **▲/▼** key to select “POS REQUEST”, then press the **SELECT** soft key. The “POS Request Call” menu will appear. The previous six position request contacts will be listed.
3. Press the **▲/▼** key to select a name that you want to contact, then press the **SELECT** soft key.
Press the **NEW ID** soft key to select an individual other than those on the display.
4. Press the **▲/▼** key to select the nature of call (“ROUTINE” or “SAFETY”), then press the **SELECT** soft key.
5. Press the **YES** soft key to transmit the position request DSC call.
6. When the **GX1600** and **GX1700** receive the position from the polled vessel it is shown on the radio display and also transferred to a GPS chart plotter with NMEA DSC and DSE sentences.
7. Press the **QUIT** soft key to return to radio operation.

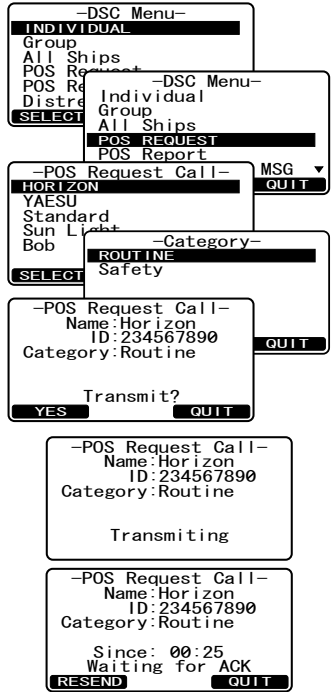

NOTE

“SAFETY” is normally used as the category for position request calls. However, “ROUTINE” should be selected when calling a vessel with radios of certain legacy models that cannot accept position request calls categorized as “SAFETY”.

NOTE

If the **GX1600** and **GX1700** do not receive a position data from the polled vessel, the display will show “NO POSITION DATA.”

9.7.2.2 Position Request by Manually Entering a MMSI

You may enter an MMSI number manually to contact a vessel without storing the MMSI in the individual/position call directory.

1. Press the **CALL MENU** key. The “DSC Menu” will appear.
2. Press the **▲/▼** key to select “POS REQUEST”.
3. Press the **SELECT** soft key. The “POS Request Call” menu will appear. The previous six position request contacts will be listed.
Press the **NEW ID** soft key.
4. Press the **▲/▼** key to select the “MANUAL,” then press the **SELECT** soft key.
5. Press the **▲/▼** key to select the first number of the MMSI (nine digits) which you want to contact, then press the **SELECT** soft key to step to the next digit.
6. Repeat step 5 to set the MMSI number.
7. If a mistake was made entering in the MMSI number, repeat pressing the **BACK** soft key until the wrong digit is selected, then press the **▲/▼** key to correct the entry.
8. When finished entering the MMSI number, press and hold the **SELECT** soft key.
9. Press the **▲/▼** key to select the nature of call (“ROUTINE” or “SAFETY”), then press the **SELECT** soft key.

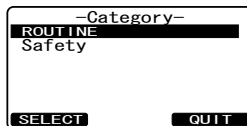
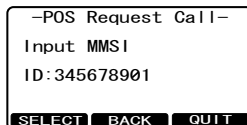
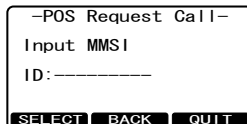
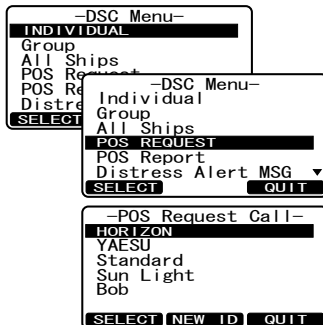

NOTE

“SAFETY” is normally used as the category for position request calls. However, “ROUTINE” should be selected when calling a vessel with radios of certain legacy models that cannot accept position request calls categorized as “SAFETY”.

10. Press the **YES** soft key to transmit the position request DSC call.
11. When the **GX1600** and **GX1700** receive the position from the polled vessel it is shown on the radio display and also transferred to the GPS chart plotter with NMEA DSC and DSE sentences.
12. Press the **QUIT** soft key to return to radio operation.

```

-POS Request Call-
Name:
ID:345678901
Category:Routine

Transmit?
YES QUIT

```

```

-POS Request Call-
Name:
ID:345678901
Category:Routine

Transmitting

```

```

-POS Request Call-
Name:
ID:345678901
Category:Routine

Since: 00:25
Waiting for ACK
RESEND QUIT

```

9.7.3 Receiving a Position Request

When a position request call is received from another vessel, a ringing alarm sounds and "POS REQUEST" will be shown in the display. Operation and transceiver function differs depending on the setting of the "Position Reply" in the "DSC Setup" menu.

Automatic reply:

1. When a position request call is received, a calling alarm sounds 4 times. Then requested position coordinates are transmitted automatically to the vessel requesting your vessels position. (DSC BEEP needs to be enabled to hear alarm.)
2. The display shows the MMSI number.

```

Received POS Request
Name:Horizon
ID:123456789
Category:Routine

Since: 01:03
QUIT

```

Manual reply:

1. When a position request call is received from another vessel, the display will be as shown in the illustration at the right. (DSC BEEP needs to be enabled to hear alarm.)
2. A ringing alarm sounds 2 minutes. Press any key to stop the alarm.
3. To send your vessels position to the requesting vessel, press the **REPLY** soft key. Or to exit from position request display, press the **QUIT** soft key.

```

Received POS Request
Name:Horizon
ID:123456789
Category:Routine

Since: 01:03
REPLY QUIT

```

```

Received POS Request
Name:Horizon
ID:123456789
Category:Routine

Since: 01:03
Transmitted
QUIT

```

9.7.4 Setting up the Position Request Ringer

The **GX1600** and **GX1700** have the capability to turn off the position request ringer.

1. Press and hold the **CALL MENU** key until “Setup Menu” appears.
2. Press the **▲/▼** key to select “DSC SETUP” menu.
3. Press the **SELECT** soft key, then select “DSC BEEP” with the **▲/▼** key.
4. Press the **SELECT** soft key, then select “POS Request” with the **▲/▼** key.
5. Press the **ENT** soft key, then select “Off” with the **▲/▼** key.
6. Press the **ENT** soft key to store the selected setting.
7. Press the **QUIT** soft key three times to return to radio operation.

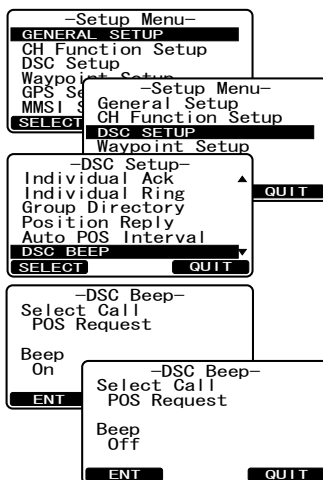

To re-enable the ringer tone, repeat the above procedure, pressing the **▲/▼** key to select “On” in the step 5 above.

9.8 POSITION REPORT

The feature is similar to the position request, however instead of requesting a position of another vessel this function allows you to send your position to another vessel. Your vessel must mark the connected GPS receiver for the **GX1600** and the internal GPS receiver for the **GX1700** to send the position.

NOTE

To transmit a position report call, a GPS must be connected to the radio and the individual directory of the **GX1600** and **GX1700** must be programmed with stations you wish to send your position to. To setup this directory refer to section “**9.5.1 Individual / Position Call Directory Setup.**”

9.8.1 Transmitting a DSC Position Report Call

9.8.1.1 DSC Position Report Call using the Individual/Position Call Directory

1. Press the **CALL MENU** key. The “DSC Menu” will appear.
2. Press the **▲/▼** key to select “POS REPORT”. (To cancel, press the **QUIT** soft key.)
3. Press the **SELECT** soft key. The transceiver will beep, and the “POS Report Call” menu will appear. The previous six position report contacts will be listed.
4. Press the **▲/▼** key to select the name in the directory, then press the **SELECT** soft key. Press the **NEW ID** soft key to select an individual other than those on the display.
5. Press the **▲/▼** key to select the nature of call (“ROUTINE” or “SAFETY”), then press the **SELECT** soft key.
6. Press the **YES** soft key to send your position to the selected vessel.
7. Press the **QUIT** key to return to radio operation.

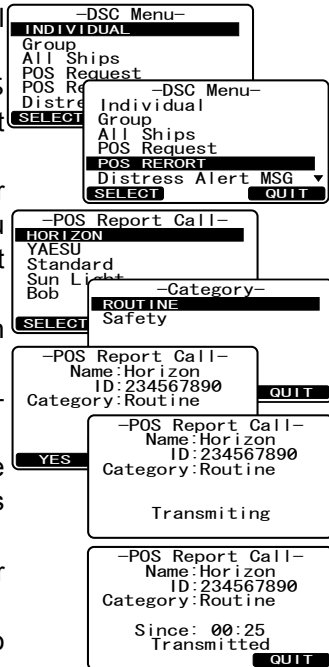

NOTE

“SAFETY” is normally used as the category for position report calls. However, “ROUTINE” should be selected when calling a vessel with radios of certain legacy models that cannot accept position report calls categorized as “SAFETY”.

9.8.1.2 DSC Position Report Call by Manually Entering a MMSI

You may enter an MMSI number manually to contact a vessel without storing the MMSI in the individual/position call directory.

1. Press the **CALL MENU** key. The “DSC Menu” will appear.
2. Press the **▲/▼** key to select “POS REPORT”. (To cancel, press the **QUIT** soft key.)
3. Press the **SELECT** soft key. The transceiver will beep, and the “POS Report Call” menu will appear. The previous six position report contacts will be listed.
Press the **NEW ID** soft key.
4. Press the **▲/▼** key to select “MANUAL”, then press the **SELECT** soft key.
5. Press the **▲/▼** key to select the first number of the MMSI which you want to contact, then press the **SELECT** soft key to step to the next digit.
6. Repeat step 5 to set the MMSI number.
7. If a mistake was made entering in the MMSI number, repeat pressing the **BACK** soft key until the wrong digit is selected, then press the **▲/▼** key to correct the entry.
8. When finished entering the MMSI number, press and hold the **SELECT** soft key.
9. Press the **▲/▼** key to select the nature of call (“ROUTINE” or “SAFETY”), then press the **SELECT** soft key.

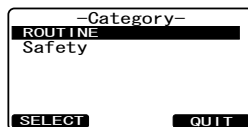
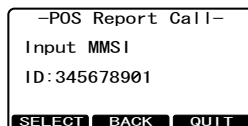
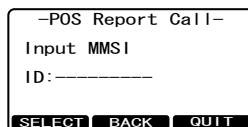
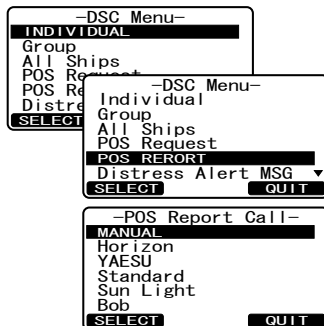

NOTE

“SAFETY” is normally used as the category for position report calls. However, “ROUTINE” should be selected when calling a vessel with radios of certain legacy models that cannot accept position report calls categorized as “SAFETY”.

- Press the **YES** soft key to send your position to the selected vessel.
- Press the **QUIT** soft key to return to radio operation.

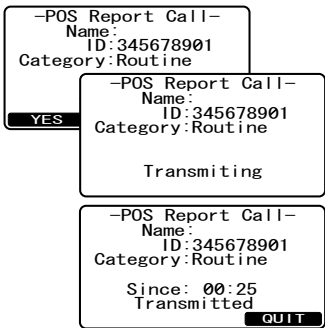

9.8.2 Receiving a DSC Position Report Call

When another vessel transmits their vessels location to the **GX1600** or **GX1700** the following will happen:

- A ringing sound will be produced when the call is received and NMEA sentences DSC, DSE are outputted so the position can be shown on a connected chart plotter or a computer. (DSC BEEP needs to be enabled to hear alarm.)
- Press any key to stop ringing.
- Press the **▲/▼** key to see position information of the station.
- To exit to radio mode, press the **QUIT** soft key.



9.8.3 Navigating to a Position Report

The **GX1600** and **GX1700** have a feature that allows navigation to a received position report call by using the compass display. Navigating to the location of a position report call may be enabled by the procedure below.

- After the position report call has been received, press the **TO WPT** soft key.
- To start navigating using the compass display, press and hold the **ENT** soft key twice. The compass page will appear that indicates the distance and direction of the received vessel, and the compass indicates the received vessel by a dot (●) icon.

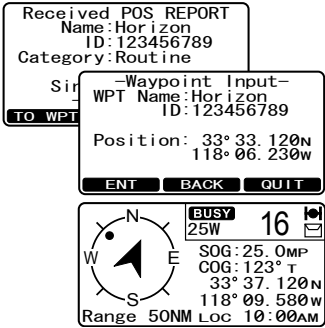

9.8.4 Stopping Navigation to Position Report

To stop navigating to a waypoint, press one of the soft keys, then press the **STOP** soft key. The radio is switched to the normal mode.

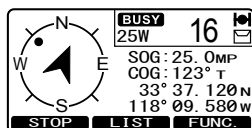

9.8.5 Saving a Position Report Call as a Waypoint

The **GX1600** and **GX1700** can save a position report call in the radios memory as a waypoint.

1. After the position report call has been received, press the **SAVE** soft key.
2. Press the key to change the first letter in the name of the waypoint and press the **ENT** soft key.
3. Repeat step 2 until the WPT name is entered.
4. Press and hold the **ENT** soft key to save the waypoint into memory.

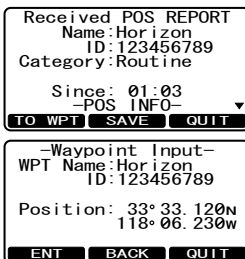

9.8.6 Navigating to a Saved Waypoint

1. Press and hold the key until "Setup Menu" appears.
2. Select "GENERAL SETUP" with the key.
3. Press the **SELECT** soft key, then select "DISPLAY" with the key.
4. Press the key to select "WAYPOINT" and press the **ENT** soft key.
5. Press the key to select the waypoint name and press the **ENT** soft key.
6. Press the **ENT** key to show the compass display and to navigate to the waypoint. The display indicates the distance and direction of the saved waypoint, and the compass indicates the saved waypoint by a dot (●) icon.

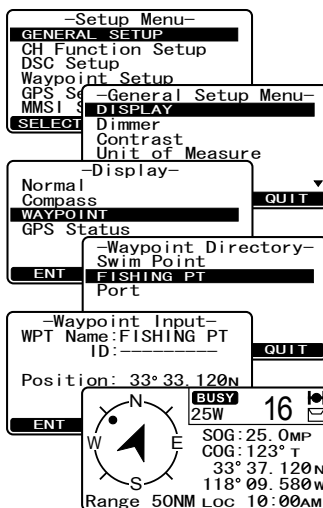

9.8.7 Stopping Navigation to a Saved Waypoint

1. Press and hold the **CALL MENU** key until “Setup Menu” appears.
2. Select “GENERAL SETUP” with the **▲/▼** key.
3. Press the **SELECT** soft key.
4. Select “DISPLAY” with the **▲/▼** key, and press the **SELECT** soft key.
5. Select “NORMAL” with the **▲/▼** key, and press the **ENT** soft key.

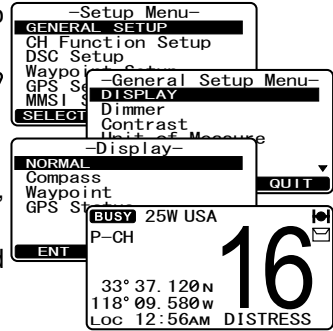

9.8.8 Setting up the Position Report Ringer

The **GX1600** and **GX1700** have the capability to turn off the position report ringer.







1. Press and hold the **CALL MENU** key until “Setup Menu” appears.
2. Press the **▲/▼** key to select “DSC SETUP” menu.
3. Press the **SELECT** soft key, then select “DSC BEEP” with the **▲/▼** key.
4. Press the **SELECT** soft key, then select “POS Report” with the **▲/▼** key.
5. Press the **ENT** soft key, then select “Off” with the **▲/▼** key.
6. Press the **ENT** soft key to store the selected setting.
7. Press the **QUIT** soft key three times to return to radio operation.



To re-enable the ringer tone, repeat the above procedure, pressing the **▲/▼** key to select “On” in the step 5 above.

9.9 MANUAL INPUTTING A GPS POSITION (LAT/LON)

This selection allows the latitude and longitude of your vessel to be manually entered so a DSC distress or a position report call will contain position information. This feature may be useful when a GPS connected to the **GX1600** fails to supply position to the radio, or when the **GX1700** is located in an area where GPS reception is limited.

1. Press and hold the  key until "Setup Menu" appears, then select "GPS SETUP" with the  /  key.
2. Press the **SELECT** soft key, then select "POSITION INPUT" with the  /  key.
3. Press the **SELECT** soft key. The display will be as shown in the illustration on the right.
4. Enter UTC time in the 24-hour format and the latitude and longitude of your vessel. Press the  /  key to select the number and press the **ENT** soft key to move the cursor to the next character. If you make a mistake, you may backspace the cursor by pressing the **BACK** soft key.
5. To store the data entered, press and hold the **ENT** soft key.
6. Press the **QUIT** soft key three times to return to radio operation.

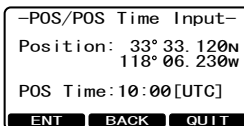
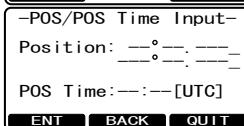
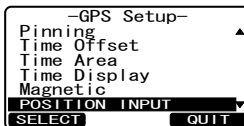
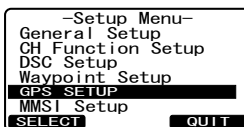
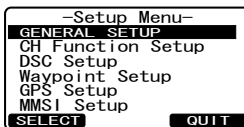





9.10 AUTO POS POLLING

The **GX1600** and **GX1700** have the capability to automatically track four stations programmed into the individual directory.

9.10.1 Setting up the Polling Time Interval

The following steps allow the radio to setup the interval time between DSC position request transmissions.

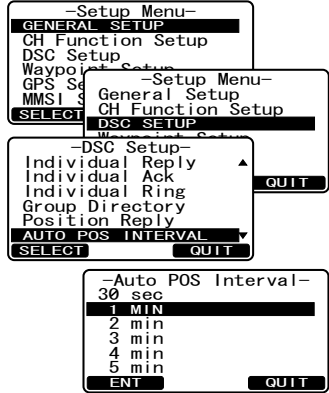

1. Press and hold the  key until “Setup Menu” appears.
2. Press the  key to select “DSC SETUP” menu.
3. Press the **SELECT** soft key, then select “AUTO POS INTERVAL” with the  key.
4. Press the  key to select the desired interval time (30 seconds, 1, 2, 3, 4, 5, 10, 20, 30, and 40 minutes) and press the **ENT** soft key.
5. Press the **QUIT** soft key twice to exit to the radio mode.





9.10.2 Selecting Stations to be Automatically Polled (Tracked)

NOTE

The radio uses the individual directory to select stations. Refer to section “9.5.1 Individual / Position Call Directory Setup” and to enter the MMSI of stations you want to poll before proceeding.

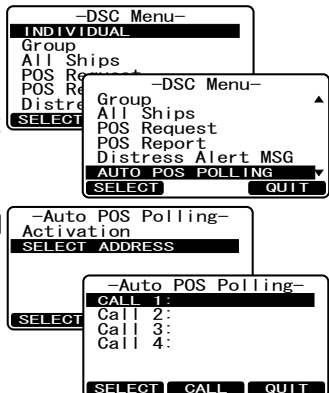



1. Press the  key. The “DSC Menu” will appear.
2. Press the  key to select “AUTO POS POLLING”, then press the **SELECT** soft key.
3. Press the  key to select the “SELECT ADDRESS”, then press the **SELECT** soft key.
4. The radio will show 4 calling stations to be selected, select “CALL 1” and press the **SELECT** soft key.

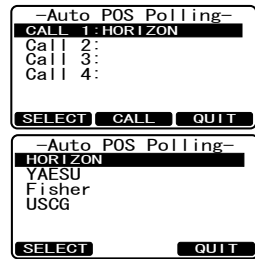

- The radio will show the stations programmed in the individual directory. Press the  /  key to select the desired station and press the **SELECT** soft key.
- Repeat steps 4 and 5 for CALL 2, CALL 3 and CALL 4 entries.
- When finished, press the **QUIT** soft key three times to exit to the radio mode.



9.10.3 Enable/Disable Auto POS Polling

- Press the  key. The “DSC Menu” will appear.
- Press the  /  key to select “AUTO POS POLLING”, then press the **SELECT** soft key.
- Press the  /  key to select the “ACTIVATION”, then press the **SELECT** soft key.
- Select “START” to enable transmissions to the stations or “STOP” to disable transmissions to stations.
- Press the **ENT** soft key.
- Press the **QUIT** soft key twice to exit to the radio mode.

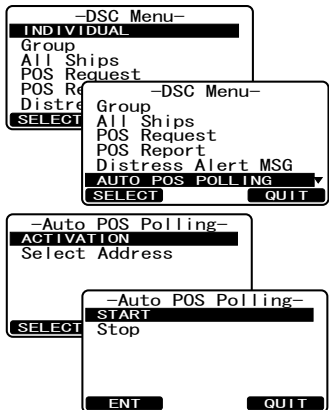

NOTE

When the radio receives position reports from a called vessel the display will show the image as in the right also NMEA 0183 DSC and DSE sentences are outputted to a connected GPS chart plotter or PC.

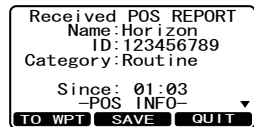

9.11 DSC TEST CALL

This function is used to contact another DSC equipped vessel or USCG station to ensure the DSC functions of the radio are operating.

NOTE

To use this feature, the radio you will be transmitting the test call to needs to have the DSC test feature.

To perform the DSC test you will need to enter a MMSI of another vessel into the individual directory or manually enter in the MMSI using the procedure below.

9.11.1 Programming MMSI into Individual/Position Call Directory

Refer to section “9.5.1 Setting up the Individual / Position Call Directory”.

9.11.2 DSC Test Call by using Individual/Position Call Directory

1. Press the **CALL MENU** key. The “DSC Menu” will appear.
2. Press the **▲** / **▼** key to select “DSC TEST”, then press the **SELECT** soft key.
3. Press the **▲** / **▼** key to select the ship’s name and press the **SELECT** soft key.
4. Press the **YES** soft key to transmit the DSC test call to the other vessel.

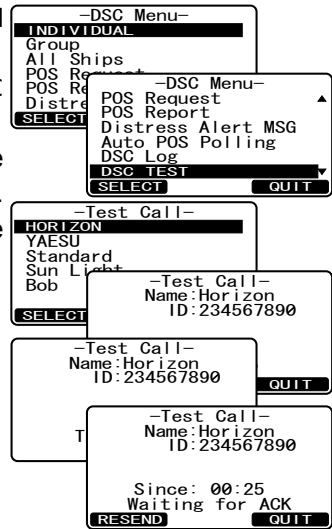







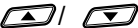

NOTE

After the radio receives a test call reply from the vessel that was called, the radio will ring and show the image as in the right, which confirms the radio you called received the test call.

Received TEST ACK
Name: Standard
ID: 123456789
Category: Routine
Since: 00:25
QUIT

9.11.3 DSC Test Call by Manually Entering a MMSI

1. Press the  key. The “DSC Menu” will appear.
2. Press the  key to select “DSC TEST”, then press the  soft key.
3. Press the  key to select “MANUAL” and press the  soft key.
4. Press the  key to select the first number in the MMSI and press the  soft key.
5. Repeat step 4 until all the digits of the MMSI are shown on the display.
6. Press and hold the  soft key to show the test call page.
7. Press the  soft key to transmit the DSC test call to the other vessel.

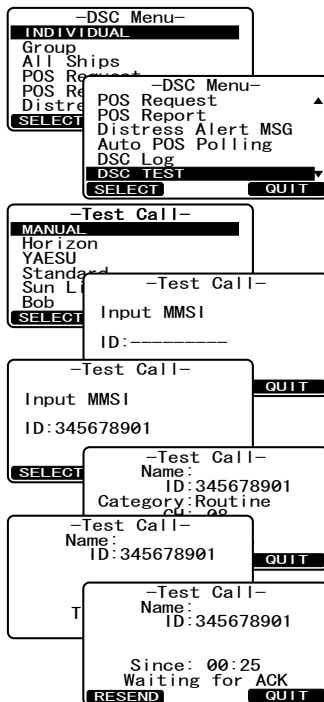

NOTE

After the radio receives a test call reply from the vessel that was called, the radio will ring and show the image as in the right, which confirms the radio you called received the test call.

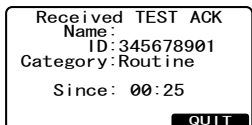

9.12 POLLING CALL

The **GX1600** and **GX1700** have the capability to track another vessel.

9.12.1 Transmitting a Polling Call to Another Vessel

9.12.1.1 Polling Call using the Individual/Position Call Directory

1. Press the **CALL MENU** key. The “DSC Menu” will appear.
2. Press the **▲/▼** key to select “POLLING”, then press the **SELECT** soft key.
3. Press the **▲/▼** key to select a name that was stored in the individual/position call directory, then press the **SELECT** soft key.
4. Press the **YES** soft key to transmit the polling call.
5. After a polling call is transmitted, if the reply signal is not received, “Waiting for ACK” is shown on the display which means the **GX1600** and **GX1700** are waiting for the vessel you called to send an acknowledgement.
6. To transmit the call again, press the **RESEND** soft key.
7. When an acknowledgement is received from the polled vessel, the **GX1600** and **GX1700** will show the display as in the right.
8. Press the **QUIT** soft key to return to radio operation.

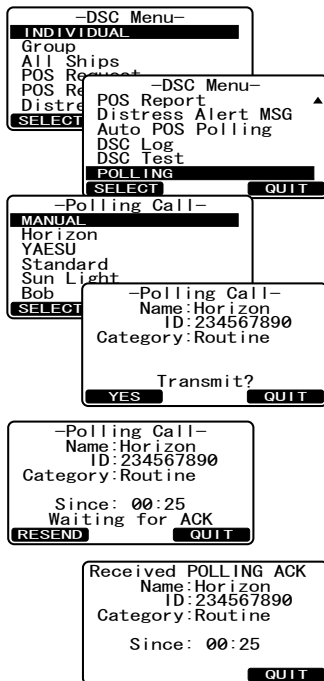

9.12.1.2 Polling Call by Manually Entering a MMSI

This feature allows you to contact a vessel by manually entering the MMSI of the ship you want to track.

1. Press the **CALL MENU** key. The “DSC Menu” will appear.
2. Press the **▲/▼** key to select “POLLING”, then press the **SELECT** soft key.
3. Press the **▲/▼** key to select “MANUAL” and press the **SELECT** soft key.
4. Press the **▲/▼** key to select the first number in the MMSI and press the **SELECT** soft key.
5. Repeat step 4 until all the digits of the MMSI are shown on the display.
6. If a mistake was made entering in the MMSI number, repeat pressing the **BACK** soft key until the wrong digit is selected, then press the **▲/▼** key to correct the entry.
7. When finished entering the MMSI number, press and hold the **SELECT** soft key.
8. Press the **YES** soft key to transmit the polling call.
9. Press the **QUIT** soft key to return to radio operation.

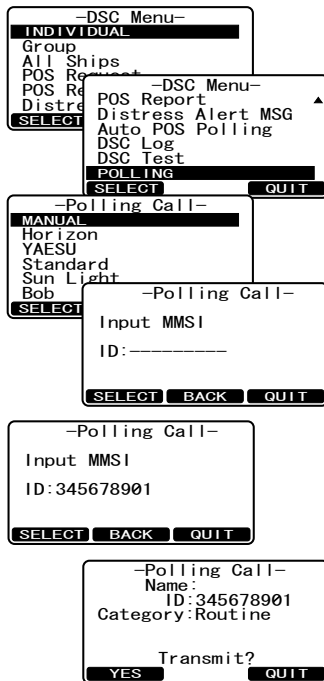

9.12.2 Receiving a Polling Call

When another vessel transmits a polling call to the **GX1600** or **GX1700** the following will happen:

1. When a polling call is received, the radio will automatically respond to the calling vessel.
2. To exit from the polling call display, press the **QUIT** soft key.

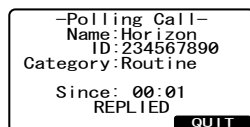

9.13 DSC LOG OPERATION

The **GX1600** and **GX1700** log transmitted calls, received DSC distress calls, and other calls (individual, group, all ships, etc.). The DSC log feature is similar to an answer machine where calls are recorded for review and a “☑” icon will appear on the radios display. The **GX1600** and **GX1700** can store up to 24 transmitted calls, up to 27 distress calls, and up to 64 other calls (all ships calls, individual calls, group calls, position report, position request ack, test call ack, and polling calls).

NOTE

When the “DSC LOG” menu is selected, the **GX1600** and **GX1700** may display high-priority logged call automatically.

9.13.1 Reviewing and Resending a Transmitted Logged Call

The **GX1600** and **GX1700** radios allow transmitted logged calls to be reviewed and to resend the call.

1. Press the **CALL MENU** key. The “DSC menu” will appear.
2. Press the **▲/▼** key to select “DSC LOG” menu.
3. Press the **SELECT** soft key, then confirm “TRANSMITTED LOG” is selected.
4. Press the **SELECT** soft key, then press the **▲/▼** key to select the station (name or MMSI number) you want to review and/or resend the call.
5. Press the **SELECT** soft key to review details for the selected station.
6. Press the **CALL** soft key to resend the call or press the **QUIT** soft key to go back to the DSC transmitted call list.

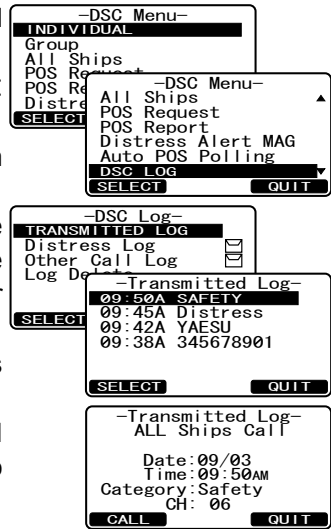

9.13.2 Reviewing DSC Distress Logged Calls

The **GX1600** and **GX1700** radios allow logged DSC distress calls to be reviewed.

1. Press the **CALL MENU** key. The “DSC Menu” will appear.
2. Press the **▲/▼** key to select “DSC LOG” menu.
3. Press the **SELECT** soft key, then press the **▲/▼** key to select “DISTRESS LOG”.
4. Press the **SELECT** soft key, then press the **▲/▼** key to select the station (name or MMSI number) you want to review.
Note: When there is an unread received call, “✉” icon will appear behind the station name (or MMSI number).
5. Press the **SELECT** soft key to review details for the selected station.
6. Press the **QUIT** soft key to go back to the DSC distress call list.

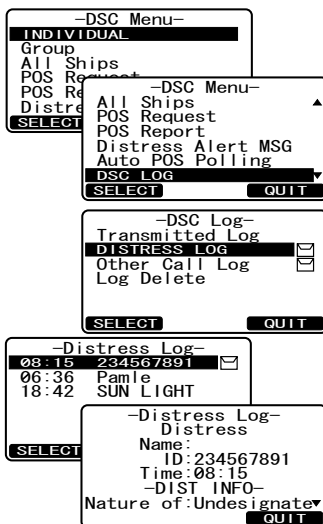



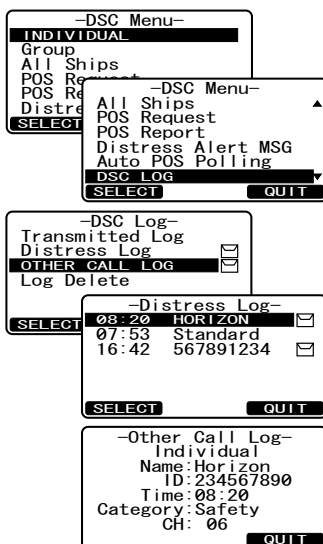

9.13.3 Reviewing Other Logged Calls

Reviewing other logged calls (all ships calls, individual calls, group calls, position report, position request ack, test call ack, and polling calls).





1. Press the **CALL MENU** key. The “DSC Menu” will appear.
2. Press the **▲/▼** key to select “DSC LOG” menu.
3. Press the **SELECT** soft key, then press the **▲/▼** key to select “OTHER CALL LOG”.
4. Press the **SELECT** soft key, then press the **▲/▼** key to select the station (name or MMSI number) you want to review.
Note: When there is an unread received call, “✉” icon will appear behind the station name (or MMSI number).
5. Press the **SELECT** soft key to review details for the selected station.
6. Press the **QUIT** soft key to go back to the DSC other call list.

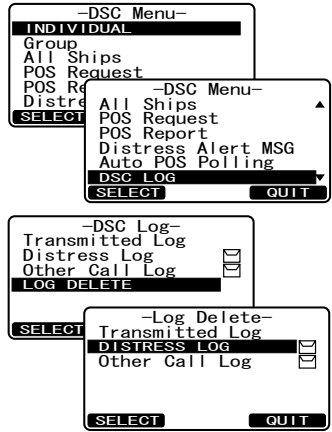

9.13.4 Deleting a Call from the “DSC LOG” Directory

1. Press the  key. The “DSC Menu” will appear.
2. Press the  key to select “DSC LOG” menu.
3. Press the **SELECT** soft key, then press the  key to select “LOG DELETE” menu.
4. Press the **SELECT** soft key, then press the  key to select the category (“TRANSMITTED LOG”, “DISTRESS LOG”, or “OTHER CALL LOG”) to be deleted.



5. Press the **SELECT** soft key.
 - 1) If you want to delete all logged calls at one time, select “ALL LOG DELETE” with the  key, press the **SELECT** soft key, then press the **OK** soft key. Press the **QUIT** soft key several times to return to radio operation.
 - 2) If you want to delete one of the logged stations, select “VIEW LOG LIST” with the  key, then press the **SELECT** soft key. Press the  /  key to select the station (name or MMSI number) to be deleted, then press the **DELETE** soft key. The display will show “Are your sure?”. Press the **OK** soft key.

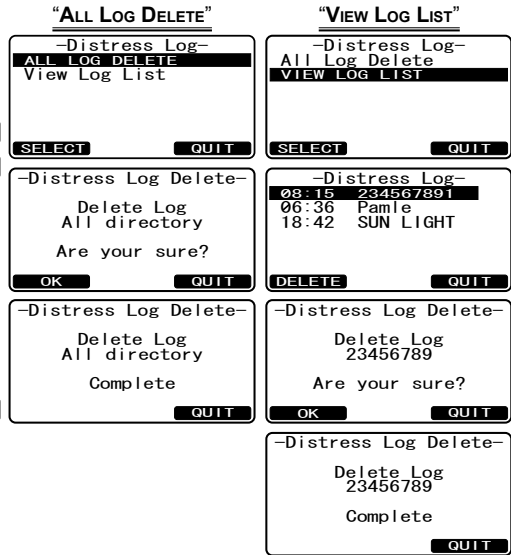

6. Press the **QUIT** soft key several times to return to radio operation.

10 GENERAL SETUP

The optional **RAM3+ (CMP31)** Remote Station Microphone can also adjust items in the setup menu using the following procedures.

10.1 DISPLAY

The **GX1600** and **GX1700** can select additional screens other than the default “NORMAL” (radio) display by using the procedure below.

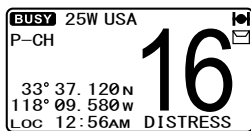

“NORMAL” DISPLAY

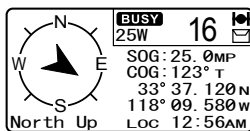

“COMPASS” DISPLAY

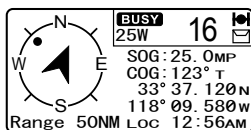

“WAYPOINT” DISPLAY

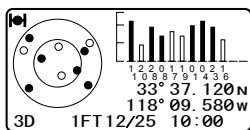

“GPS STATUS” DISPLAY

1. Press and hold the **CALL MENU** key until “Setup Menu” appears, then select “GENERAL SETUP” with the **▲/▼** key.
2. Press the **SELECT** soft key, then press the **▲** / **▼** key to select “DISPLAY”.
3. Press the **SELECT** soft key.
4. Press the **▲/▼** key to select desired screen type “NORMAL”, “COMPASS”, “WAYPOINT”, or “GPS STATUS”.
5. Press the **ENT** soft key to store the selected setting.

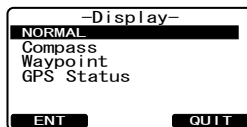
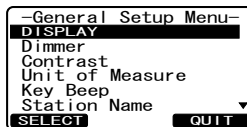
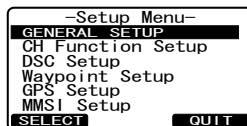

10.2 DIMMER ADJUSTING

This menu selection adjusts the backlight intensity of the display and keypad.

1. Press and hold the **CALL MENU** key until "Setup Menu" appears, then select "GENERAL SETUP" with the **▲/▼** key.
2. Press the **SELECT** soft key, then press the **▲/▼** key to select "DIMMER".
3. Press the **SELECT** soft key, then press the **▲/▼** key to select the desired level ("HIGH" is default). When "OFF" is selected, the lamp is turned off.
4. Press the **ENT** soft key to store the selected level.
5. Press the **QUIT** soft key twice to return to radio operation.

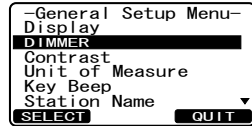
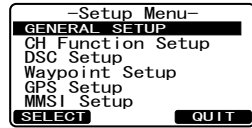

10.3 CONTRAST

This selection sets up the display contrast for overhead or dash installations.

1. Press and hold the **CALL MENU** key until "Setup Menu" appears, then select "GENERAL SETUP" with the **▲/▼** key.
2. Press the **SELECT** soft key, then press the **▲/▼** key to select "CONTRAST".
3. Press the **SELECT** soft key.
4. Press the **▲/▼** key to select the desired level. The contrast level can be set from "0" to "31".
5. Press the **ENT** soft key to store the selected level.
6. Press the **QUIT** soft key twice to return to radio operation.

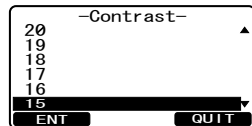
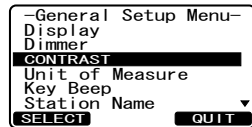
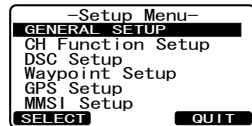









10.4 UNIT OF MEASURE

Allows navigation displays to be shown in “Knot”, “Mile/Hour” or “Kilo-Meter/Hour” (for speed), “Nautical Mile” or “Kilo-Meter” (for distance), and “Feet” or “Meter” (for altitude).

NOTE

GPS fix from the internal antenna (**GX1700**) or a NMEA signal from an external GPS or chart plotter must be received.

1. Press and hold the  key until “Setup Menu” appears, then select “GENERAL SETUP” with the  key.
2. Press the **SELECT** soft key, then press the  /  key to select “UNIT OF MEASURE”.
3. Press the **SELECT** soft key.
4. Press the  /  key to select “SPEED”, “DISTANCE”, or “ALTITUDE” which you wish to change.
5. Press the **SELECT** soft key, then press the  /  key to select desired unit. Available selections are KTS (knot), MPH (Mile/Hour), or KMH (Kilo-Meter/Hour) for speed, NM (Nautical Mile), SM (Statute Mile) or KM (Kilo-Meter) for distance, and FT (feet) or M (Meter) for altitude.
6. Press the **ENT** soft key to store the selected setting.
7. Press the **QUIT** soft key three times to return to radio operation.

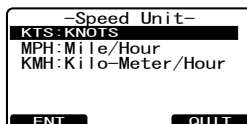
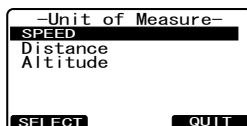
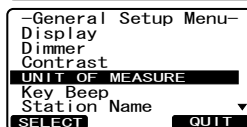
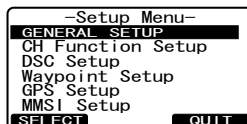









10.5 MAGNETIC

Refer to the section “6.10 CHANGING COG TO TRUE OR MAGNETIC”.

10.6 KEY BEEP





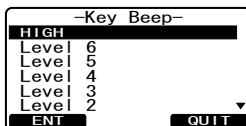
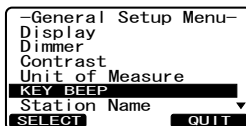
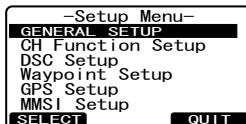

This selection is used to select the beep tone volume level when a key is pressed.

1. Press and hold the  key until “Setup Menu” appears, then select “GENERAL SETUP” with the  key.
2. Press the  soft key, then press the  /  key to select “KEY BEEP”.
3. Press the  soft key.
4. Press the  key to select the desired level. The beep level can be set from “LEVEL 1” to “LEVEL 6”, “HIGH”, or “OFF”.
5. Press the  soft key to store the selected level.
6. Press the  soft key twice to return to radio operation.



10.7 STATION NAME

This function allows you to change the name of the radio or **RAM3+** second station microphone. Example: "Radio - Cabin", "RAM1 - Flybridge".



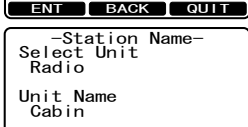
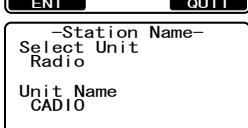
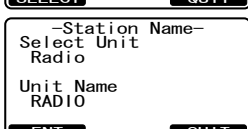
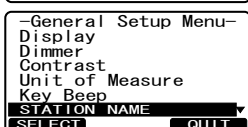
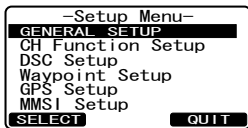





1. Connect the **RAM3+** second station microphone to the **GX1600** or **GX1700**.
2. Press and hold the  key until "Setup Menu" appears, then select "GENERAL SETUP" with the  key.
3. Press the **SELECT** soft key, then press the  /  key to select "STATION NAME".
4. Press the **SELECT** soft key.
5. Press the  key to select the unit ("Radio" or "RAM1") to be named, then press the **ENT** soft key.
6. Press the  key to scroll through the first letter of the new channel name.
7. Press the **ENT** soft key to store the first letter in the name and step to the next letter to the right.
8. Repeat step 6 and 7 until the name is completed. The name can consist of up to 8 characters, if you do not use all 8 characters press the **ENT** soft key to move to the next space. This method can also be used to enter a blank space in the name. If a mistake was made entering in the name repeat pressing the **BACK** key until the wrong character is selected, then press the  key to correct the entry.
9. Press and hold the **ENT** soft key to enter the name.
10. If you want to enter the name of the connected **RAM3+** or radio, repeat steps 5 through 9.
11. Press the **QUIT** soft key several times to return to radio operation.



10.8 SOFT KEYS







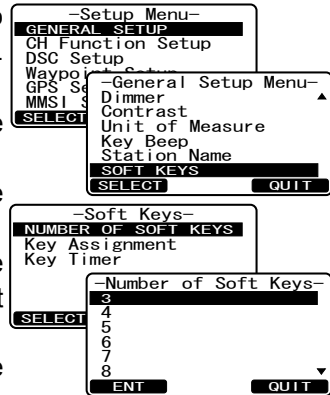



This menu item assigns the number of soft keys, soft key selection and how long the display will show the soft key icon after a soft key is pressed.

10.8.1 Selecting the Number of Soft Keys

1. Press and hold the  key until "Setup Menu" appears, then select "GENERAL SETUP" with the / key.
2. Press the **SELECT** soft key, then press the / key to "SOFT KEYS".
3. Press the **SELECT** soft key, then press the / key to "NUMBER OF SOFT KEYS".
4. Press the **SELECT** soft key, then press the / key to select the number of soft keys ("3" through "10").
5. Press the **ENT** soft key to store the selected setting.
6. Press the **QUIT** soft key three times to return to radio operation.



10.8.2 Assigning Soft Keys

1. Press and hold the  key until "Setup Menu" appears, then select "GENERAL SETUP" with the / key.
2. Press the **SELECT** soft key, then press the / key to "SOFT KEYS".
3. Press the **SELECT** soft key, then press the / key to select "KEY ASSIGNMENT" (to change the function of selected soft keys).
4. Press the **SELECT** soft key, then press the / key to select the key ("KEY1", "KEY2", or "KEY3") that you want to change.
5. Press the **SELECT** soft key, then press the / key to select the new function to be assigned, and press the **SELECT** soft key. Available functions are listed below.

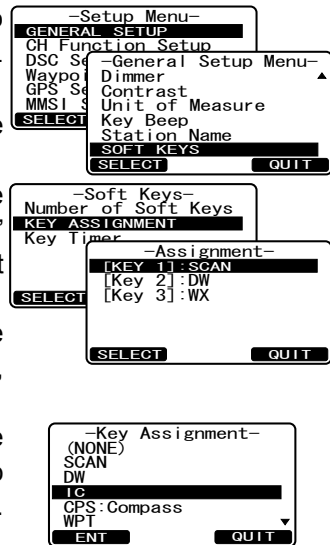

DISPLAY	FUNCTION
SCAN	Starts and stops scanning.
DW	Starts and stops dual watch scan.
IC	Activates intercom between radio and RAM3+ mic (optional RAM3+ required).
CMP: COMPASS	Shows to the "Compass" display.
WPT	Shows to the "Waypoint" navigation display.
PRESET	Saves or deletes the preset memory channel.
WX	Immediately recalls the last select the weather channel.
MARK	Marks the current position for a "Waypoint".
PRESET 0-9	Immediately recalls the preset memory channel.

- Repeat steps 4 and 5 to program the other soft keys. The factory defaults are Key 1: **SCAN**, Key 2: **DW**, and Key 3: **WX** function.
- Press the **ENT** soft key to store the selected setting.
- Press the **QUIT** soft key three times to return to radio operation.

10.8.3 Selecting How Long the Soft Keys are Shown

- Press and hold the **CALL MENU** key until "Setup Menu" appears, then select "GENERAL SETUP" with the **▲/▼** key.
- Press the **SELECT** soft key, then press the **▲/▼** key to "SOFT KEYS".
- Press the **SELECT** key, then press the **▲/▼** key to select "KEY TIMER" (selects how long the soft key icon will be shown on the display after a soft key is pressed, default is 4 seconds). Then, press the **SELECT** soft key.
- Press the **▲/▼** key to select the time.
- Press the **ENT** soft key to store the selected setting.
- Press the **QUIT** soft key three times to return to radio operation.







11 CHANNEL FUNCTION SETUP

11.1 CHANNEL GROUP

(USA, CANADA or INTERNATIONAL BAND SELECTION)



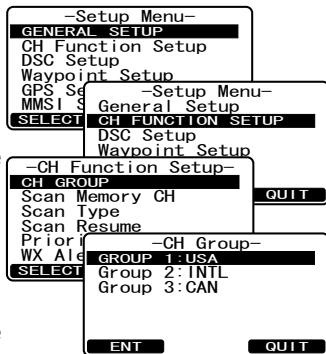

To change the channel group from USA, Canada, and International.

1. Press and hold the  key until "Setup Menu" appears.
2. Press the  key to select "CH FUNCTION SETUP".
3. Press the **SELECT** soft key, then press the  key to select "CH GROUP".
4. Press the **SELECT** soft key.
5. Press the  key to select desired channel group "USA", "INTL", or "CAN".
6. Press the **ENT** soft key to store the selected setting.
7. Press the **QUIT** soft key twice to return to radio operation.



11.2 SCAN MEMORY CHANNEL



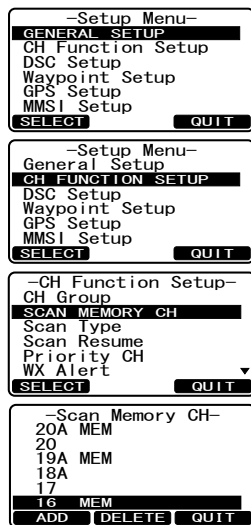

To be able to scan channels the radio must be programmed. This section allows channels to be stored in scan memory.

1. Press and hold the  key until "Setup Menu" appears.
2. Press the  key to select "CH FUNCTION SETUP".
3. Press the **SELECT** soft key, then press the  key to select "SCAN MEMORY CH".
4. Press the **SELECT** soft key.
5. Press the  key to select a desired channel to be scanned, then press the **ADD** key. "MEM" icon appears on the display, which indicates the channel has been selected to the scan channel.
6. Repeat step 5 for all the desired channels to be scanned.
7. To DELETE a channel from the list, select the channel then press the **DELETE** key. "MEM" icon disappears from the display.
8. Press the **QUIT** soft key three times to return to radio operation.



11.3 SCAN TYPE



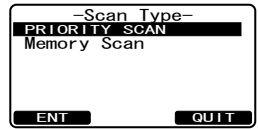
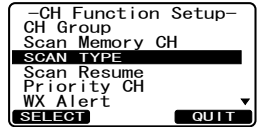
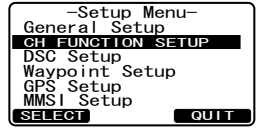
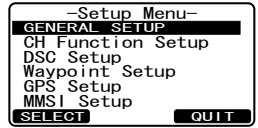

This selection is used to select the scan mode between “Memory Scan” and “Priority Scan”. The default setting is “Priority Scan”.

1. Press and hold the  key until “Setup Menu” appears.
2. Press the  key to select “CH FUNCTION SETUP”.
3. Press the **SELECT** soft key, then select “SCAN TYPE” with the  key.
4. Press the **SELECT** soft key.
5. Press the  key to select “PRIORITY SCAN” or “MEMORY SCAN”.
6. Press the **ENT** soft key to store the selected setting.
7. Press the **QUIT** soft key twice to return to radio operation.



11.4 SCAN RESUME





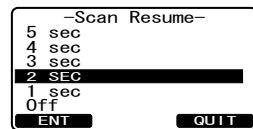
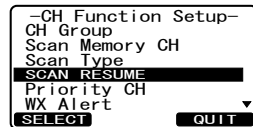
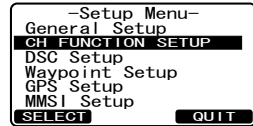
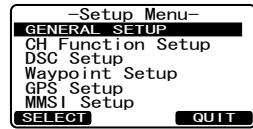



This selection is used to select the time the **GX1600** and **GX1700** wait after a transmission ends before the radio starts to scan channels again. The default setting is 2 seconds.

1. Press and hold the  key until "Setup Menu" appears.
2. Press the  key to select "CH FUNCTION SETUP".
3. Press the **SELECT** soft key, then select "SCAN RESUME" with the  key.
4. Press the **SELECT** soft key.
5. Press the  key to select the desired resume time, default is 2 seconds. The resume time can be set to "1SEC" through "5SEC", or "OFF". In the "OFF" selection, the scanner will resume after the other station stops transmitting (carrier drops).
6. Press the **ENT** soft key to store the selected setting.
7. Press the **QUIT** soft key twice to return to radio operation.



11.5 PRIORITY CHANNEL





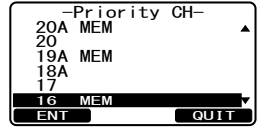
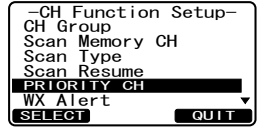
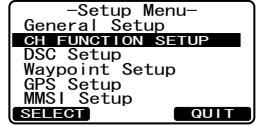
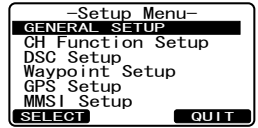



By default the radio priority channel is set to Channel 16. This procedure allows the radio to use a different priority channel when priority scanning.

1. Press and hold the  key until "Setup Menu" appears.
2. Press the  key to select "CH FUNCTION SETUP".
3. Press the  soft key, then select "PRIORITY CH" with the  key.
4. Press the  soft key.
5. Press the  key to select the desired channel to be a priority.
6. Press the  soft key to store the selected setting.
7. Press the  soft key twice to return to radio operation.



11.6 WEATHER ALERT

This menu selection allows you to toggle the WX alert "ON" or "OFF". The default setting is "ON".

1. Press and hold the  key until "Setup Menu" appears.
2. Press the  key to select "CH FUNCTION SETUP".
3. Press the  soft key, then select "WX ALERT" with the  key.
4. Press the  soft key.
5. Press the  key to select the desired WX alert mode. The WX alert mode can be set to "ON" or "OFF".
6. Press the  soft key to store the selected setting.
7. Press the  soft key twice to return to radio operation.

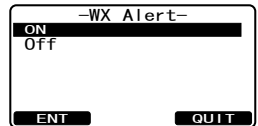
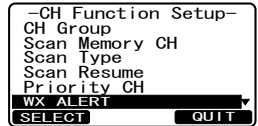
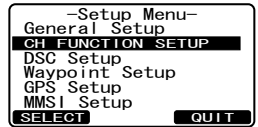
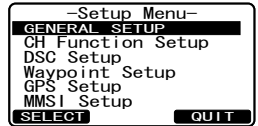

11.7 CHANNEL NAME

When the radio mode (NORMAL) is selected, the display will show a name under the channel number. This name describes the use of the channel. The radio has the capability to customize the name by the procedure below.

Example: CH69 PLEASURE to HOOKUP

1. Press and hold the **CALL MENU** key until "Setup Menu" appears.
2. Press the **▲/▼** key to select "CH FUNCTION SETUP".
3. Press the **SELECT** soft key, then select "CH NAME" with the **▲/▼** key.
4. Press the **SELECT** soft key.
5. Press the **▲/▼** key to select the channel to be named, then press the **ENT** soft key.
6. Press the **▲/▼** key to scroll through the first letter of the new channel name.
7. Press the **ENT** soft key to store the first letter in the name and step to the next letter to the right.
8. Repeat step 6 and 7 until the name is completed. The name can consist of up to 16 characters, if you do not use all 16 characters press the **ENT** soft key to move to the next space. This method can also be used to enter a blank space in the name. If a mistake was made entering in the name repeat pressing the **BACK** key until the wrong character is selected, then press the **▲/▼** key to correct the entry.
9. Press and hold the **ENT** soft key to save the name.
10. If you want to enter the name of another channel, repeat steps 5 through 9.
11. Press the **QUIT** soft key three times to return to radio operation.

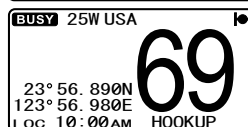
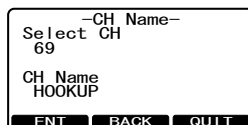
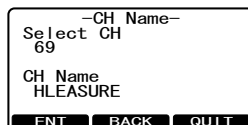
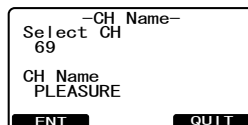
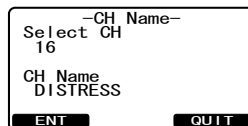
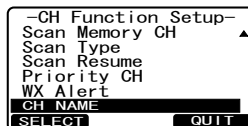
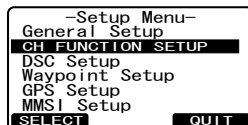
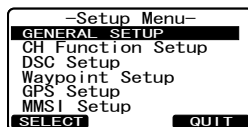

12 DSC SETUP

12.1 INDIVIDUAL DIRECTORY

The **GX1600** and **GX1700** have a DSC directory that allows you to store a vessel's or person's name and the MMSI number associated with vessels you wish to transmit individual calls, position requests and position reports.

To transmit an individual call you must program this directory with information of the persons you wish to call, similar to a cellular phones telephone directory.

Refer to section “**9.5.1 Setting up the Individual / Position Call Directory**” for programming.

12.2 INDIVIDUAL REPLY

This menu item sets up the radio to automatically (default setting) or manually respond to a DSC individual call requesting you to switch to a working channel for voice communications. When “Manual” is selected the MMSI of the calling vessel is shown allowing you to see who is calling. This function is similar to caller ID on a cellular phone.

Refer to section “**9.5.2 Setting up the Individual Call Reply**” for setting.

12.3 INDIVIDUAL ACKNOWLEDGMENT

The radio can be setup to transmit a reply automatically (default) or set so the radio will not reply to an individual call.

Refer to section “**9.5.3 Setting up the Individual Call Acknowledgment**” for setting.

12.4 INDIVIDUAL RINGER

The radio can be setup to ring like a telephone to alert you the radio received a DSC individual call. The default setting is 2 minutes, however this can be changed to 15, 10 or 5 seconds.

Refer to section “**9.5.6 Setting up the Individual Call Ringer**” for setting.

12.5 GROUP DIRECTORY

For this function to operate, the same group MMSI must be programmed into all the DSC VHF radios within the group of vessels that will be using this feature.

Refer to section “**9.6.1 Setting up the Group Call**” for programming.

12.6 POSITION REPLY

The **GX1600** and **GX1700** can be set up to automatically (default setting) or manually send your position when requested by another vessel. This selection is important if you are concerned about someone polling the position of your vessel that you may not want to. In the manual mode you will see the MMSI or persons name shown on the display allowing you to choose to send your position to the requesting vessel.

Refer to section “**9.7.1 Setting up the Position Reply**” for setting.

12.7 AUTO POSITION INTERVAL











The **GX1600** and **GX1700** have the capability to automatically track four stations programmed into the individual directory.

Selecting the auto position polling time interval between position request transmissions to be setup.

Refer to section “**9.10 AUTO POS POLLING**” for setting.

12.8 DSC BEEP

This feature allows the alarm beeps to be turned on (default setting) or off when a DSC call is received. The DSC calls that can be customized are: Individual, Group, All Ships, Position Request, Position Report, Geographical Call using the procedure below:



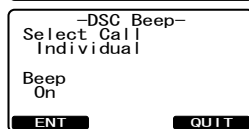
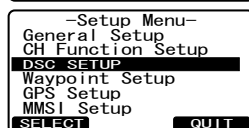





1. Press and hold the  key until “Setup Menu” appears.
2. Press the  key to select “DSC SETUP”.
3. Press the  soft key, then select “DSC BEEP” with the  key.
4. Press the  soft key, then press the  /  key to the desired DSC call type and press the  soft key.
5. Press the  key to turn “On” or “Off” the DSC beep and press the  soft key.
6. Press the  soft key three times to return to radio operation.



12.9 AUTO CHANNEL SWITCH TIME

When a DSC distress or an all ships (urgency or safety) call is received, the **GX1600** and **GX1700** will automatically switch to Channel 16.

This menu selection allows the automatic switch time to be changed. The default selection is 30 seconds.



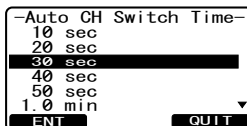
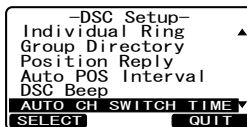
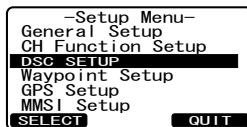





1. Press and hold the  key until "Setup Menu" appears.
2. Press the  key to select "DSC SETUP".
3. Press the  soft key, then select "AUTO CH SWITCH TIME" with the  key.
4. Press the  soft key, then press the  /  key to the desired time and press the  soft key.
5. Press the  soft key twice to return to radio operation.



12.10 NO ACTION TIMER ON MENU OPERATION

If a key is not pressed during the setup menu or the DSC menu mode, the **GX1600** and **GX1700** will automatically return to radio operation.

This menu selection allows the automatic switch time to be changed. The default selection is 10 minutes.

1. Press and hold the  key until "Setup Menu" appears.
2. Press the  key to select "DSC SETUP".
3. Press the  soft key, then select "NO ACT TIMER ON MENU" with the  key.
4. Press the  soft key, then press the  /  key to the desired time and press the  soft key.
5. Press the  soft key twice to return to radio operation.

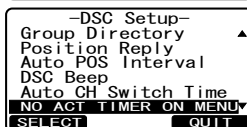
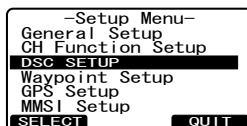

12.11 NO ACTION TIMER ON DSC OPERATION

If a key is not pressed during the DSC operation, the **GX1600** and **GX1700** will automatically return to radio operation.

This menu selection allows the automatic switch time to be changed. The default selection is 15 minutes.

1. Press and hold the **CALL MENU** key until "Setup Menu" appears.
2. Press the **▲/▼** key to select "DSC SETUP".
3. Press the **SELECT** soft key, then select "NO ACT TIMER ON DSC" with the **▲/▼** key.
4. Press the **SELECT** soft key, then press the **▲/▼** key to the desired time and press the **ENT** soft key.
5. Press the **QUIT** soft key twice to return to radio operation.

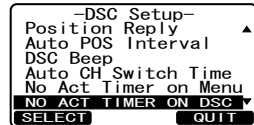
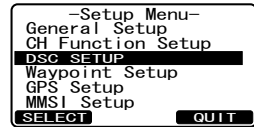

12.12 NO ACTION TIMER ON DISTRESS OPERATION

If a key is not pressed during the distress operation, the **GX1600** and **GX1700** will automatically return to radio operation.

This menu selection allows the automatic switch time to be changed. The default selection is "OFF".

1. Press and hold the **CALL MENU** key until "Setup Menu" appears.
2. Press the **▲/▼** key to select "DSC SETUP".
3. Press the **SELECT** soft key, then select "NO ACT TIMER ON DIST" with the **▲/▼** key.
4. Press the **SELECT** soft key, then press the **▲/▼** key to the desired time and press the **ENT** soft key.
5. Press the **QUIT** soft key twice to return to radio operation.

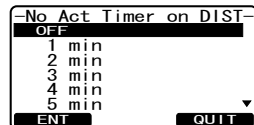
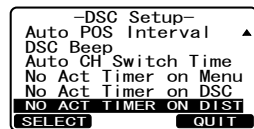
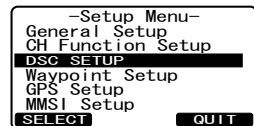









13 WAYPOINTS

The **GX1600** and **GX1700** are capable of storing up to 100 waypoints and navigating to them using the compass page.

In addition DSC distress calls with position or a position received from another DSC radio using DSC polling can be navigated to.

13.1 MARKING A POSITION

This feature allows the radio to mark the current position of the vessel.

1. Press and hold the  key until "Setup Menu" appears.
2. Press the / key to select "WAYPOINT SETUP".
3. Press the **SELECT** soft key, then select "WAYPOINT DIRECTORY" with the / key.
4. Press the **SELECT** soft key, then select "MARK POSITION" with the / key.
5. Press the **SELECT** soft key, then enter the waypoint name, by pressing the / key to select the first letter.

Note: The **GX1600** and **GX1700** assign a name of the waypoint with "WPT xxx" automatically.



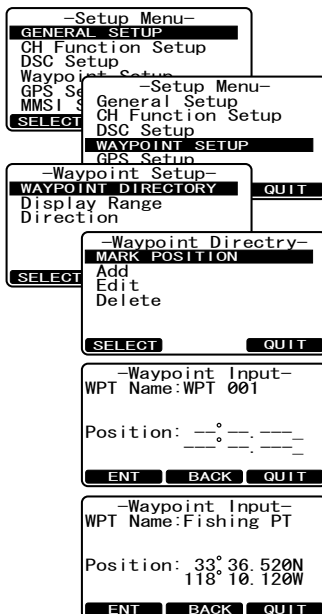





6. Press the **ENT** soft key to store the first letter and to move to the second letter in the name.
7. Repeat step 5 and 6 until the name is shown. Press the **ENT** soft key to skip a letter if needed.
8. Press and hold the **ENT** soft key twice to save the waypoint into memory.
9. Press the **QUIT** soft key three times to return to radio operation.













NOTE

One of the soft keys (refer to section "10.8 SOFT KEYS") may be assigned to **MARK** and when pressed will bring up the menu above.

13.2 ADDING A WAYPOINT





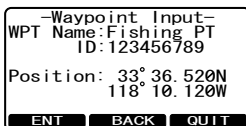
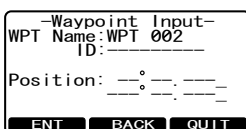
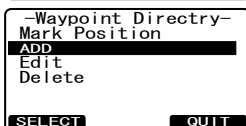
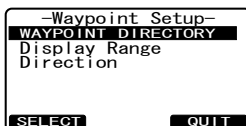
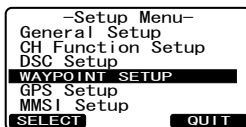
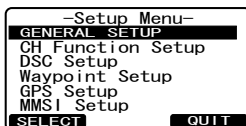





- Press and hold the  key until "Setup Menu" appears.
- Press the  key to select "WAYPOINT SETUP".
- Press the  soft key, then select "WAYPOINT DIRECTORY" with the  key.
- Press the  soft key, then select "ADD" with the  key.
- Press the  soft key.
- Enter the waypoint name by pressing the  /  key to select the first letter.

Note: The **GX1600** and **GX1700** assign a name of the waypoint with "WPT xxx" automatically.
- Press the  soft key to store the first letter and to move to the second letter in the name.
- Repeat step 6 and 7 until the name is shown. Press the  soft key to skip a letter if needed.
- Press and hold the  soft key, then enter the coordinates of the waypoint position, by pressing the  key to select the first digit in the latitude.
- Press the  soft key to store the first number and to move to the second number in the position.
- Repeat step 9 and 10 until the latitude is shown including N or S in the last digit.
- Press the  soft key to select the first digit of the longitude is blinking.
- Press the  key to select the first digit in the longitude.
- Press the  soft key to store the first number and to move to the second number in the position.
- Repeat step 13 and 14 until the longitude is shown including E or W in the last digit.
- After all information is entered, press and hold the  soft key to store the waypoint into memory.
- Press the  soft key three times to return to radio operation.



13.3 EDITING A WAYPOINT

This function allows a previously entered waypoint to be edited.

1. Press and hold the  key until "Setup Menu" appears.
2. Press the / key to select "WAYPOINT SETUP".
3. Press the **SELECT** soft key, then select "WAYPOINT DIRECTORY" with the / key.
4. Press the **SELECT** soft key, then select "EDIT" with the / key.
5. Press the **SELECT** soft key, then press the / key to select the waypoint to be edited.
6. Press the **SELECT** soft key to show the waypoint input display.
7. Press the **ENT** soft key repeatedly until the number or letter is selected that is to be changed.
8. Press the / key to change the letter or number.
9. Repeat step 7 and 8 until the waypoint is updated.
10. Press and hold the **ENT** soft key to store the edited waypoint into memory.
11. Press the **QUIT** soft key three times to return to radio operation.

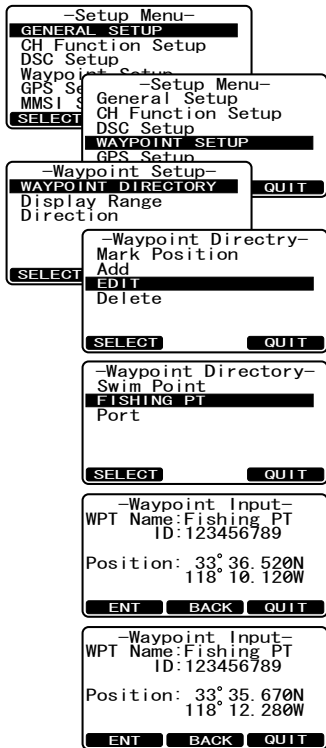

13.4 DELETING A WAYPOINT

1. Press and hold the **CALL MENU** key until "Setup Menu" appears.
2. Press the **▲/▼** key to select "WAYPOINT SETUP".
3. Press the **SELECT** soft key, then select "WAYPOINT DIRECTORY" with the **▲/▼** key.
4. Press the **SELECT** soft key, then select "DELETE" with the **▲/▼** key.
5. Press the **SELECT** soft key, then press the **▲/▼** key to highlight the waypoint to be deleted.
6. Press and hold the **ENT** soft key until the radio beeps and the waypoint directory is removed from the display.
7. Press the **QUIT** soft key three times to return to radio operation.

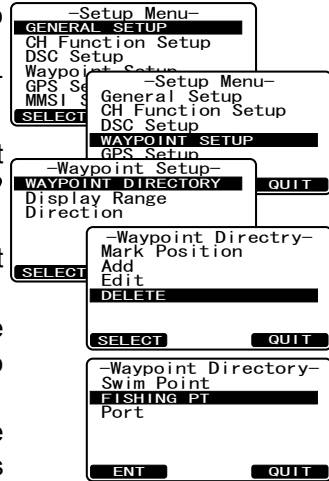

13.5 SAVING A DSC POSITION CALL AS A WAYPOINT

When a DSC position report call is received from another DSC radio the **GX1600** and **GX1700** allow the position to be saved as a waypoint.

1. After a position has been received, press the **SAVE** soft key.
2. The first digit in the waypoint name will be flashing, press the **▲/▼** key to the first letter of the name you want to input.
3. Press the **ENT** soft key, then press the **▲/▼** key to select the second letter in the name.
4. Repeat step 3 until the name is shown.
5. Press and hold the **ENT** soft key to save the waypoint to memory and return to radio operation.

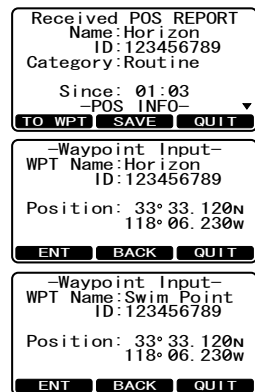

13.6 NAVIGATING TO A SAVED WAYPOINT

1. Press and hold the **CALL MENU** key until “Setup Menu” appears.
2. Press the **▲/▼** key to select “GENERAL SETUP”.
3. Press the **SELECT** soft key, then select “DISPLAY” with the **▲/▼** key.
4. Press the **SELECT** soft key, select “WAYPOINT”, then press the **ENT** soft key.
5. Select the waypoint name and press the **SELECT** soft key to show the waypoint data display.
6. Press the **ENT** soft key to start navigating to the waypoint and show the waypoint navigation display.

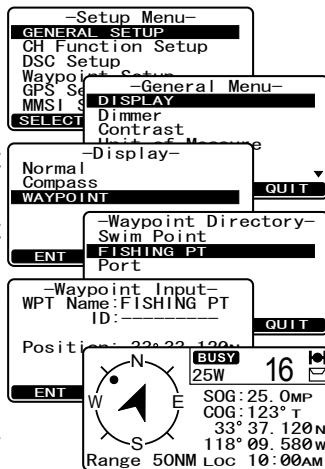

NOTE (GX1600)

The **GX1600** must be connected to a GPS to be able to navigate to a waypoint.

13.7 STOP NAVIGATING TO A WAYPOINT

To stop navigating to a waypoint, press one of the soft keys, then press the **STOP** soft key. The radio is switched to the normal mode.



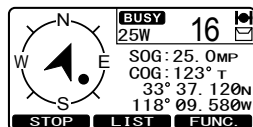





Press the **LIST** soft key to open the “Waypoint Directory” to select and navigate to a new waypoint.



13.8 WAYPOINT SETUP

13.8.1 Waypoint Range Selection





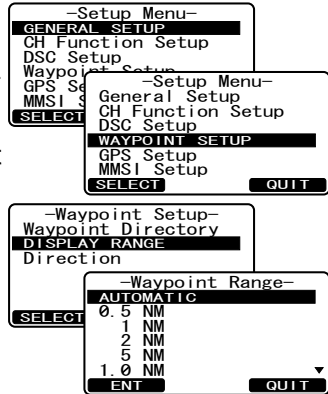



This menu item allows setting of the range on the display. The default setting is “Automatic”.

1. Press and hold the  key until “Setup Menu” appears.
2. Press the  key to select “WAYPOINT SETUP”.
3. Press the  soft key, then select “DISPLAY RANGE” with the  key.
4. Press the  soft key.
5. Press the  key to select desired range. Available selections are “Automatic”, “0.5NM”, “1NM”, “2NM”, “5NM”, “10NM”, “15NM”, “20NM”, “30NM”, “40NM”, and “50NM”.
6. Press the  soft key to store the selected setting.
7. Press the  soft key twice to return to radio operation.



13.8.2 Direction Selection

This menu item allows you to select the top of the waypoint compass to be oriented in “North Up” or “Course Up”. The default setting is “North Up”.

1. Press and hold the  key until “Setup Menu” appears.
2. Press the  key to select “WAYPOINT SETUP”.
3. Press the  soft key, then select “DIRECTION” with the  key.
4. Press the  soft key.
5. Press the  key to select desired direction.
6. Press the  soft key to store the selected setting.
7. Press the  soft key twice to return to radio operation.

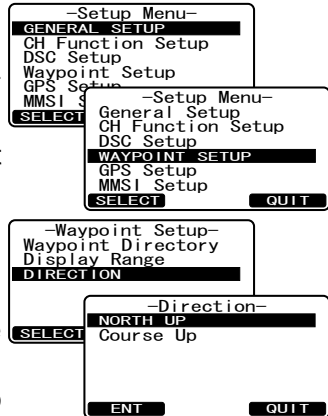









14 GPS SETUP

The “GPS Setup” mode allows the following items to be custom-configured for your operating requirements:

- Parameters for the position information from the NMEA input for the **GX1600** and **GX1700**
- Parameters for the **GX1700** internal GPS unit

14.1 UNIT POWER (GX1700)





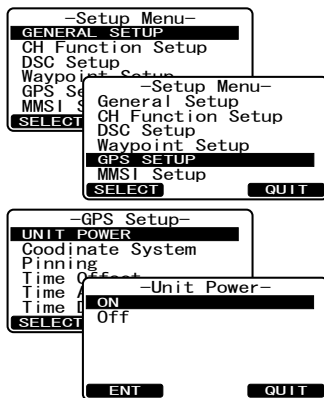



This selection allows the internal GPS unit to be turned on or off. When you use the optional Standard Horizon GPS Antenna (Q7000619A) or the radio is connected to an external chart plotter, set this selection to “OFF”. The default setting is “ON”.

1. Press and hold the  key until “Setup Menu” appears.
2. Press the  key to select “GPS SETUP”.
3. Press the  soft key, then select “UNIT POWER” with the  key.
4. Press the  soft key, then press the  key to select “On” or “Off”.
5. Press the  soft key to save the new setting.
6. Press the  soft key twice to return to radio operation.



14.2 COORDINATE SYSTEM





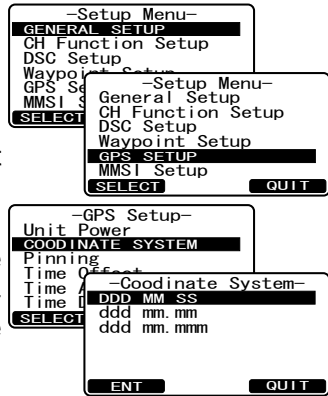



This menu item selects the coordinate system to be shown on the **GX1600** and **GX1700** display. The default setting is “ddd mm.mmm”.

1. Press and hold the  key until “Setup Menu” appears.
2. Press the  key to select “GPS SETUP”.
3. Press the  soft key, then select “COORDINATE SYSTEM” with the  key.
4. Press the  soft key, then press the  key to select the desired coordinate system. The coordinate system can be selected from “ddd mm ss”, “ddd mm.mm”, and “ddd mm.mmm”.
5. Press the  soft key to save the new setting.
6. Press the  soft key twice to return to radio operation.



14.3 PINNING (GX1700)

This selection is used to enable or disable position updates when the vessel is not underway. The default setting is “On”.

1. Press and hold the  key until “Setup Menu” appears.
 2. Press the  key to select “GPS SETUP”.
 3. Press the  soft key, then select “PINNING” with the  key.
 4. Press the  soft key, then press the  key to select “On” or “Off”.
- On: When pinning is turned on, the **GX1700** will not update its position unless the vessel travels over 10Ft.
- Off: When the vessel is underway or stopped, the **GX1700** continuously updates its position (unless transmitting). This improves accuracy of the position fix.
5. Press the  soft key to save the new setting.
 6. Press the  soft key twice to return to radio operation.

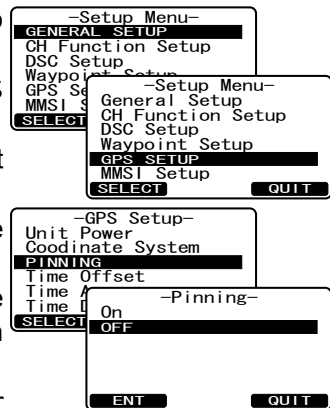

14.4 TIME OFFSET

From the factory the **GX1600** and **GX1700** shows GPS satellite time or UTC time. A time offset is needed to show the local time in your area. The time offset must be changed in order for the radio to display the current time in your area. Refer to section “**6.7 CHANGING THE GPS TIME**” for setting.

14.5 TIME AREA

This selection allows the radio to show UTC time or local time with the offset. Refer to section “**6.8 CHANGING THE TIME AREA**” for setting.

14.6 TIME DISPLAY

This selection allows the radio to setup to show time in 12-hour or 24-hour format. Refer to section “**6.9 CHANGING THE TIME DISPLAY**” for setting.

14.7 MAGNETIC

This selection allows the GPS COG (Course Over Ground) to be selected to show in “True” or “Magnetic”. Factory default is “True” however the COG can be changed to “Magnetic”. Refer to section “**6.10 CHANGING COG TO TRUE OR MAGNETIC**” for setting.

14.8 POSITION INPUT

This selection allows the latitude and longitude of your vessel to be manually entered so a DSC distress or a position report call will contain position information. This feature maybe useful when the **GX1600** and **GX1700** is located in an area where GPS reception is limited. Refer to section “**9.9 MANUAL INPUTTING A GPS POSITION (LAT/LON)**” for setting.





14.9 GPS SELECTION (GX1700)

This selection allows the **GX1700** to:

- a. use the internal GPS to compute and display position information (default setting).
- b. use the NMEA output of Standard Horizon GPS Antenna (Q7000619A) to input position information into the **GX1700** when the GPS reception is limited, such as the flush mounting of the **GX1700**. Refer to page 15 for connections. This is a useful feature when the **GX1700** is located in an area where GPS reception is limited.

NOTE



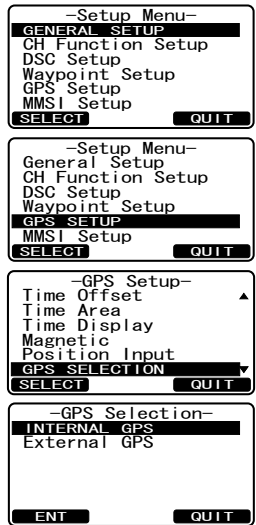

When using an external GPS antenna or chart plotter to input position data, turn off the GPS receiver, refer to section “**14.1 UNIT POWER (GX1700)**”.

1. Press and hold the  key until "Setup Menu" appears.
2. Press the  key to select "GPS SETUP".
3. Press the **SELECT** soft key, then select "GPS SELECTION" with the  key.
4. Press the **SELECT** soft key, then press the  /  key to select "INTERNAL GPS" or "EXTERNAL GPS".
5. Press the **ENT** soft key to save the new setting.
6. Press the **QUIT** soft key twice to return to radio operation.



14.10 SBAS (Satellite Based Augmentation System) (GX1700)

This selection enables or disables SBAS such as WAAS, EGNOS and MSAS as some areas (Australia for example) can have problems with GPS reception with SBAS enabled. The default setting is "ON".

1. Press and hold the  key until "Setup Menu" appears.
2. Press the  key to select "GPS SETUP".
3. Press the **SELECT** soft key, then select "SBAS" with the  key.
4. Press the **SELECT** soft key, then press the  /  key to select "ON" or "OFF".
5. Press the **ENT** soft key to save the new setting.
6. Press the **QUIT** soft key twice to return to radio operation.

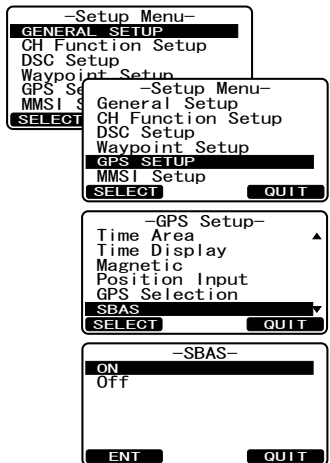

14.11 NMEA OUTPUT (GX1700)

This selection is used to setup the NMEA output sentences of the **GX1700**. By default, all the NMEA sentences are turned “Off”.

1. Press and hold the **CALL MENU** key until “Setup Menu” appears.
2. Press the **▲/▼** key to select “GPS SETUP”.
3. Press the **SELECT** soft key, then select “NMEA OUTPUT” with the **▲/▼** key.
4. Press the **SELECT** soft key, then press the **▲/▼** key to select the desired sentence. Available sentences are “GLL”, “GGA”, “GSA”, “GSV”, and “RMC”.
5. Press the **ENT** soft key, then press the **▲/▼** key to select “On” or “Off”.
6. Press the **ENT** soft key to save the new setting.
7. Press the **QUIT** soft key three times to return to radio operation.

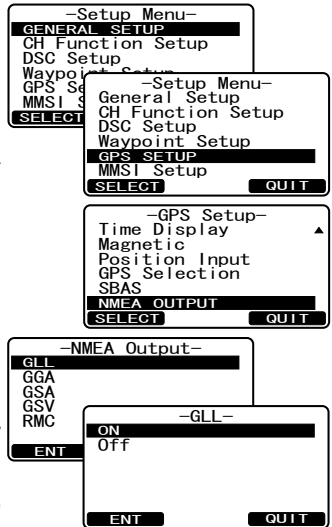

15 RAM3+ (CMP31) REMOTE MIC OPERATION

When an optional **RAM3+** Remote microphone is connected to the **GX1600** or **GX1700**, all VHF, DSC, setup menus, waypoint, and compass functions can be remotely operated. The **RAM3+**'s operation is same as the **GX1600** and **GX1700** except the receiver audio volume setting and squelch level setting. The reason for the same operation is to make the operation of the radio and **RAM3+** easy. For specific operation of the **RAM3+** review sections in the radio manual. The **RAM3+** is supplied with 23 feet (7 m) of routing cable and can be extended up to 70 feet (21 m) using three 23-foot extension cables model **CT-100**. The intercom feature can be used between the **RAM3+** and the **GX1600** or **GX1700**. In addition, speaker wires are supplied at the panel mount of the routing cable for external speakers to be connected in noisy environments.

15.1 REMOTE MIC CONTROLS

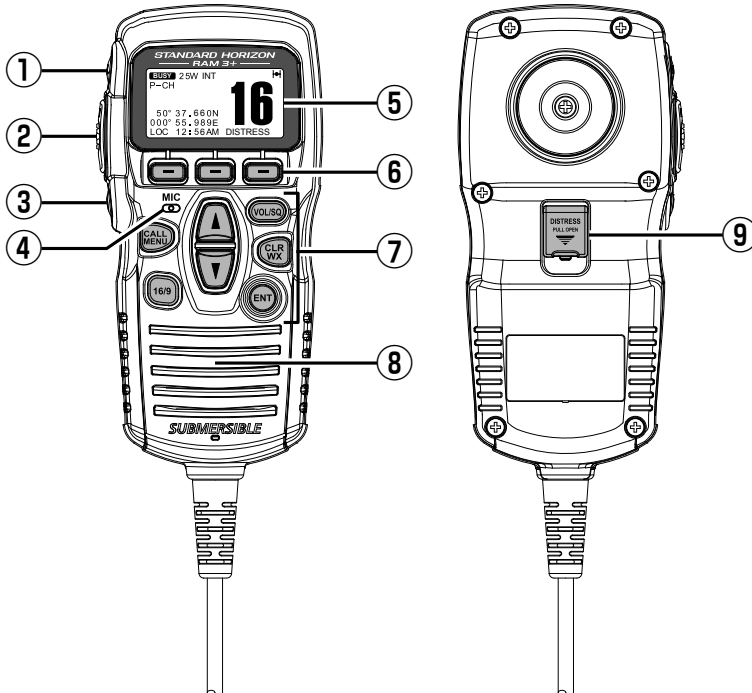

① **H/L** KEY

Toggles between high and low power. When the **H/L** key is pressed while the transceiver is on CH13 or CH67, the power is temporarily switched from LO to HI until the **PTT** switch is released. The **H/L** key does not function on transmit inhibited and low-power only channels.

② **PTT (Push-To-Talk) Key**

Push this key to enable the transmitter.

③  **(POWER) Key**

Press and hold this key to turn the transceiver and the remote microphone on or off.

④ **MICROPHONE**

The internal ClearVoice Noise Canceling microphone is located here.

When transmitting, position your mouth about 1/2 to 1 inch (1.2 ~ 2.5 cm) away from the small microphone hole. Speak slowly and clearly into the microphone.

⑤ **DISPLAY**

Full dot matrix display.

⑥ **SOFT KEY**

These three key's functions can be customized by the setup menu mode. When pressing one of these keys briefly, the key functions will appear at the bottom of the display. Refer to section "**15.2 ASSIGNING SOFT KEYS**" for details.

⑦ **KEY PAD**



Key

Press this key to access the DSC menu.

Press and hold this key to access the setup menu.



Key

First press: Channel 16 is immediately selected.

Second press: recalls the last selected channel.

Press and hold: selects Channel 9.



(UP) /  **(DOWN) Key**

These keys are used to select channels, adjust the volume and squelch level, and to choose DSC calls, DSC setup and general setup function.





Key (Volume Control / Squelch Control)

First press: volume adjustment mode

Second press: squelch adjustment mode

Third press: exits adjustment mode

When in volume or squelch mode, press the  or  key to adjust the level.



Key

Press to CLEAR a function or menu selection. Press and hold to select

NOAA Weather channels. Press and hold again to exit the weather mode and revert to the radio mode.

Secondary use

Press and hold the **(169)** key while pressing the **(CLR WX)** key to change the mode from USA to International or Canadian.

(ENT) Key

This key functions as the enter key.

8 SPEAKER

The internal speaker is located here.

9 [DISTRESS] KEY

Used to send a DSC distress call. Refer to section “9 DIGITAL SELECTIVE CALLING”.

15.2 ASSIGNING SOFT KEYS

This menu item allows selection of the number of soft keys, soft key selection and how long the display will show the soft key icon after a soft key is pressed. The keys may be setup to control the following functions:

DISPLAY	FUNCTION
SCAN	Starts and stops scanning.
DW	Starts and stops dual watch scan.
IC	Activates Intercom between radio and RAM3+ mic (optional RAM3+ required).
CMP: COMPASS	Shows to the “Compass” display.
WPT	Shows to the “Waypoint” navigation display.
PRESET	Saves or deletes the preset memory channel.
WX	Immediately recalls the last select the weather channel.
MARK	Marks the current position for a “Waypoint”.
PRESET 0-9	Immediately recalls the preset memory channel.

- Press and hold the **(CALL MENU)** key until “Setup Menu” appears, then select “GENERAL SETUP” with the **(▲)** or **(▼)** key.
- Press the **(SELECT)** soft key, then press the **(▼)** key to select “SOFT KEY”.
- Press the **(SELECT)** soft key, then press the **(▼)** key to select “NUMBER OF SOFT KEYS”.
- Press the **(SELECT)** soft key, then press the **(▲)** or **(▼)** key to select the number of soft keys (“3” through “10”).
- Press the **(ENT)** soft key, then press the **(▼)** key to select “KEY ASSIGNMENT” (to change the use of selected soft keys). Then press the **(SELECT)** soft key.

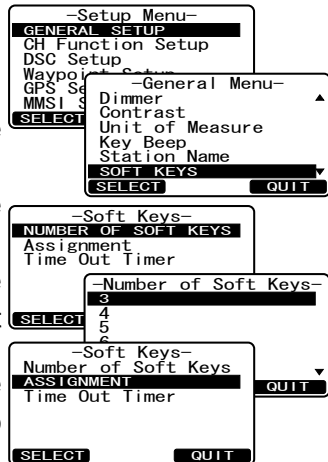

6. Press the **▲** or **▼** key to select the key (“KEY1”, “KEY2”, “KEY3” etc), and press the **SELECT** soft key. Then press the **▲** or **▼** key to select the new function to be assigned, and press the **ENT** soft key. Available functions are listed in the previous page. Repeat step 6 to program the other soft keys.

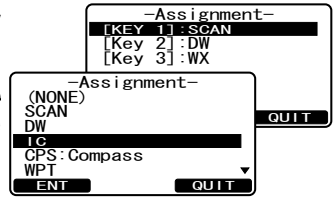

7. Press the **QUIT** soft key, then press the **▲** or **▼** key to select “KEY TIMER” (selects how long the soft key icon will be shown on the display after a soft key is pressed, default is 5 seconds). Then, press the **SELECT** soft key.

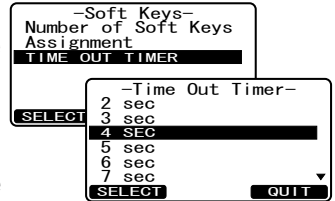

8. Press the **▲** or **▼** key to select the time.

9. Press the **ENT** soft key to store the selected setting.

10. Press the **QUIT** soft key several times to return to radio operation.

16 MAINTENANCE

The inherent quality of the solid-state components used in this transceiver will provide many years of continuous use. Taking the following precautions will prevent damage to the transceiver.

- Never key the microphone unless an antenna or suitable dummy load is connected to the transceiver.
- Ensure that the supply voltage to the transceiver does not exceed 16 VDC or fall below 11 VDC.
- Use only STANDARD HORIZON-approved accessories and replacement parts.

In the unlikely event of serious problems, please contact your Dealer or our repair facility. Address and phone numbers for this facility, as well as warranty information, are contained in section “**18 WARRANTY.**”

16.1 REPLACEMENT PARTS

Occasionally an owner needs a replacement mounting bracket or knob. These can be ordered from our Parts Department by emailing yaesuparts@yaesu.com or calling:

Marine Division of YAESU U.S.A.

6125 Phyllis Drive, Cypress, California 90630

Telephone (714) 827-7600

Commonly requested parts, and their part numbers are listed below.

- **Power Cord:** T9025406
- **VOL and SQL Knob:** RA128250A (White), RA128260A (Black)
- **Mounting Bracket:** RA1283100 (White), RA1283200 (Black)
- **Mounting Bracket Knob:** RA0978500 (White), RA0978600 (Black)
- **Microphone Hanger:** RA0436000 (White), RA0458800 (Black)
- **RAM3+ Mic Routing Cable Assembly:** S8101512

16.2 FACTORY SERVICE

In the unlikely event that the radio fails to perform or needs servicing, please contact the following:

Standard Horizon

Attention Marine Repair Department

6125 Phyllis Drive, Cypress, California 90630, U.S.A.

Telephone (800) 366-4566

For repairs in Canada

Westcom Marine

488 East 62nd Avenue Vancouver BC V5X2G1

Telephone (604) 327-6280

An "RA" (Return Authorization) number is not necessary to send a product in for service. Include a brief note describing the problem along with your name, return address, phone number, and proof of purchase.

16.3 TROUBLESHOOTING CHART

SYMPTOM	PROBABLE CAUSE	REMEDY
Transceiver fails to power up.	No DC voltage to the transceiver, or blown fuse.	a. Check the 12VDC battery connections and the fuse. b. The  key needs to be pressed and held to turn the radio on.
Transceiver blows fuse when connected to power supply.	Reversed power wires.	Check the power cable for DC voltage, or replace the fuse (6A). Make sure the red wire is connected to the positive (+) battery post, and the black wire is connected to the negative (-) battery post. If the fuse still blows, contact your Dealer.
Popping or whining noise from the speaker while engine runs.	Engine noise.	Re-route the DC power cables away from the engine. Add noise suppressor on power cable. Change to resistive spark plug wires and/or add an alternator whine filter.
Sound is not emitted from the internal or external speaker.	Accessory cable.	Check the connections of the accessory cable. External speaker cable (WHITE/SHIELD) shorted together.
Receiving station reports low transmit power, even with transceiver set to HI power.	Antenna.	Have the antenna checked or test the transceiver with another antenna. If the problem persists, contact your Dealer for servicing.
“HI BATTERY” or “LO BATTERY” message appears when the power is turned on.	The power supply voltage is too high or too low.	Confirm that the connected power supply voltage is between 11 volts and 16.5 volts DC.
Your position is not displayed on the Chart Plotter.	Accessory cable.	Check the accessory cable connection. Some GPS Chart Plotters use the battery ground for NMEA connection.
	Setting of the GPS chart plotter.	Check the output signal format of the GPS chart plotter. This radio requires NMEA0183 format with GLL, RMB, or RMC sentence as an input signal. If the GPS has a baud rate setting make sure to select 4800 and parity to NONE.

17 CHANNEL ASSIGNMENTS

Tables on the following columns list the VHF Marine Channel assignments for U.S.A. and International use. Below are listed some data about the charts.

1. VTS. Where indicated, these channels are part of the U.S. Coast Guard's Vessel Traffic System.
2. Alpha channel numbers, that is, channel numbers followed by the letter A (such as Channel 07**A**) are **simplex** channels on the U.S.A. or Canadian channel assignments whose counterparts in the International assignments are **duplex** channels. International channels do not use "alpha" numbers. If you call the Coast Guard on Channel 16, they will sometimes ask you to "**go to channel 22 Alpha.**" This is a channel assigned to U.S.A., and Canadian Coast Guards for handling distress and other calls. If your radio is set for **International** operation you will go to Channel 22 instead of 22**A**, and will not be able to communicate with the Coast Guard. To use Channel 22**A**, your radio must be set for **USA** or **Canada** operation, usually by a U/I/C (USA/International/Canada) control or combination of controls. Channel 22 (without an "A") is an **International** duplex channel for port operations. Some radios indicate an "A" adjacent to the alpha channels on the display; on others "alpha" is not indicated but the proper channel is selected based on the U/I/C setting.
3. Bridge-to-Bridge channels (for example, Channel 13) are for use by bridge operators on inter-coastal waterways and rivers. It is also used by marine vessels in the vicinity of these bridges for navigation and for communicating with the bridge operators. Note that a limit of 1 Watt is specified for these channels.
4. The **S/D** column on the chart indicates either S (simplex) or D (duplex). **Simplex** means transmitting and receiving on the same frequency. Only one party at a time can talk, unlike a telephone. Be sure to say "**over**" and release your microphone push-to-talk switch at the end of each transmission. **Duplex** operation involves the use of one frequency for transmitting and a separate frequency for receiving. On channels specified as duplex on the charts, correct mode of operation is established automatically by your radio when you select a channel; you cannot change the mode. And you still must release the push-to-talk switch after each transmission in order to listen to the radio.
5. Channels normally used by recreational boaters are those that include the term "non-commercial" in the **Channel Use** column of the chart. Some of these are shared with other users and some are used only in certain geographic regions.

6. Marine vessels equipped with VHF radios are required to monitor Channel 16.
7. 156.050 MHz and 156.175 MHz are available for port operations and commercial communications purposes when used only within the U.S. Coast Guard designated Vessel Traffic Services (VTS) area of New Orleans, on the lower Mississippi River from the various pass entrances in the Gulf of Mexico to Devil's Swamp Light at River Mile 242.4 above head of passes near Baton Rouge.
8. 156.250 MHz is available for port operations communications use only within the U.S. Coast Guard designated VTS radio protection areas of New Orleans and Houston described in Sec. 80.383. 156.250 MHz is available for intership port operations communications used only within the area of Los Angeles and Long Beach harbors, within a 25- nautical mile radius of Point Fermin, California.
9. 156.550 MHz, 156.600 MHz and 156.700 MHz are available in the U.S. Coast Guard designated port areas only for VTS communications and in the Great Lakes available primarily for communications relating to the movement of ships in sectors designated by the St. Lawrence Seaway Development Corporation or the U.S. Coast Guard. The use of these frequencies outside VTS and ship movement sector protected areas is permitted provided they cause no interference to VTS and ship movement communications in their respective designated sectors.
10. Use of 156.875 MHz is limited to communications with pilots regarding the movement and docking of ships. Normal output power must not exceed 1 watt. 5: 156.375 MHz and 156.650 MHz are available primarily for intership navigational communications. These frequencies are available between coast and ship on a secondary basis when used on or in the vicinity of locks or drawbridges. Normal output power must not exceed 1 watt. Maximum output power must not exceed 10 watts for coast stations or 25 watts for ship stations.
11. On the Great Lakes, in addition to bridge-to-bridge communications, 156.650 MHz is available for vessel control purposes in established vessel traffic systems. 156.650 MHz is not available for use in the Mississippi River from South Pass Lighted Whistle Buoy "2" and Southwest Pass entrance Mid-channel Lighted Whistle Buoy to mile 242.4 above Head of Passes near Baton Rouge. Additionally it is not available for use in the Mississippi River-Gulf Outlet, the Mississippi River-Gulf Outlet Canal, and the Inner Harbor Navigational Canal, except to aid the transition from these areas.

12. Use of 156.375 MHz is available for navigational communications only in the Mississippi River from South Pass Lighted Whistle Buoy "2" and Southwest Pass entrance Mid channel Lighted Whistle Buoy to mile 242.4 above head of Passes near Baton Rouge, and in addition over the full length of the Mississippi River-Gulf Outlet Canal from entrance to its junction with the Inner Harbor Navigation Canal, and over the full length of the Inner Harbor Navigation Canal from its junction with the Mississippi River to its entry to Lake Pontchartrain at the New Seabrook vehicular bridge.
13. Within 120 km (75 miles) of the United States/Canada border, in the area of the Puget Sound and the Strait of Juan de Fuca and its approaches, 157.425 MHz is half of the duplex pair designated as Channel 88. In this area, Channel 88 is available to ship stations for communications with public coast stations only. More than 120 km (75 miles) from the United States/Canada border in the area of the Puget Sound and the Strait of Juan de Fuca, its approaches, the Great Lakes, and the St. Lawrence Seaway, 157.425 MHz is available for intership and commercial communications. Outside Puget Sound area and its approaches and the Great Lakes, 157.425 MHz is also available for communications between commercial fishing vessels and associated aircraft while engaged in commercial fishing activities.
14. When the frequency 156.850 MHz is authorized, it may be used additionally for search and rescue training exercises conducted by state or local governments.
15. The frequency 156.850 MHz is additionally available to coast stations on the Great Lakes for transmission of scheduled Coded Marine Weather Forecasts (MAFOR), Great Lakes Weather Broadcast (LAWEB) and scheduled Notices to Mariners or Bulletins. F3C and J3C emissions are permitted. Coast Stations on the Great Lakes must cease weather broadcasts which cause interference to stations operating on 156.800 MHz until the interference problem is resolved.
16. The frequency 157.100 MHz is authorized for search and rescue training exercises by state or local government in conjunction with U.S. Coast Guard stations. Prior U.S. Coast Guard approval is required. Use must cease immediately on U.S. Coast Guard request.
17. The duplex pair for channel 20 (157.000/161.600 MHz) may be used for ship to coast station communications.
18. Available for assignment to coast stations, the use of which is in accord with an agreed program, for the broadcast of information to ship stations concerning the environment.

VHF MARINE CHANNEL CHART									
CH	U	C	I	S/D	TX		RX		CHANNEL USE
01		X	X	D	156.050	160.650	Public Correspondence (Marine Operator)		
01A	X			S	156.050		Port Operation and Commercial. VTS in selected areas		
02		X	X	D	156.100	160.700	Public Correspondence (Marine Operator)		
03		X	X	D	156.150	160.750	Public Correspondence (Marine Operator)		
03A	X			S	156.150		U.S. Government Only, Coast Guard		
04			X	D	156.200	160.800	Public Correspondence (Marine Operator), Port operation, ship movement		
04A		X		S	156.200		Pacific coast: Coast Guard, East Coast: Commercial fishing		
05			X	D	156.250	160.850	Public Correspondence (Marine Operator), Port operation, ship movement		
05A	X	X		S	156.250		Port operation. VTS in Seattle		
06	X	X	X	S	156.300		Inter-ship Safety		
07			X	D	156.350	160.950	Public Correspondence (Marine Operator), Port operation, ship movement		
07A	X	X		S	156.350		Commercial		
08	X	X	X	S	156.400		Commercial (Inter-ship only)		
09	X	X	X	S	156.450		Boater Calling channel, Commercial & Non-commercial (Recreational)		
10	X	X	X	S	156.500		Commercial		
11	X	X	X	S	156.550		Commercial. VTS in selected areas.		
12	X	X	X	S	156.600		Port operation. VTS in selected areas.		
13	X	X	X	S	156.650		Inter-ship Navigation Safety (Bridge-to- bridge)		
14	X	X	X	S	156.700		Port operation. VTS in selected areas.		
15	X			S	---	156.750	Environmental (Receive only)		
15		X	X	S	156.750		Commercial, non-commercial, ship movement (1 W)		
16	X	X	X	S	156.800		International Distress, Safety and Calling		
17	X	X	X	S	156.850		State Controlled (1 W)		
18			X	D	156.900	161.500	Port operation, ship movement		
18A	X	X		S	156.900		Commercial		
19			X	D	156.950	161.550	Port operation, ship movement		
1019			X	S	156.950				
2019			X	S	161.550				
19A	X			S	156.950		US: Commercial		
19A		X		S	156.950		Coast Guard		
20	X	X	X	D	157.000	161.600	Canadian Coast Guard Only, International: port operations and shipment		
1020			X	S	157.000				
2020			X	S	161.600				
20A	X			S	157.000		Port operation		
21			X	D	157.050	161.650	Port operation, ship movement		
21A	X	X		S	157.050		U.S. Government Only, Canadian Coast Guard		
21B		X			---	161.650	CMB Service		
22			X	D	157.100	161.700	Port operation, ship movement		
22A	X	X		S	157.100		US and Canadian Coast Guard Liaison and Maritime Safety Information Broadcasts announced on channel 16		
23		X	X	D	157.150	161.750	Public Correspondence (Marine Operator)		

VHF MARINE CHANNEL CHART									
CH	U	C	I	S/D	TX		RX		CHANNEL USE
23A	X			S	157.150		U.S. Government Only		
23B		X			---	161.750	CMB Service		
24	X	X	X	D	157.200	161.800	Public Correspondence (Marine Operator)		
25	X	X	X	D	157.250	161.850	Public Correspondence (Marine Operator)		
25B		X			---	161.850	CMB Service		
26	X	X	X	D	157.300	161.900	Public Correspondence (Marine Operator)		
27	X	X	X	D	157.350	161.950	Public Correspondence (Marine Operator)		
28	X	X	X	D	157.400	162.000	Public Correspondence (Marine Operator)		
28B		X			---	162.000	CMB Service		
60		X	X	D	156.025	160.625	Public Correspondence (Marine Operator)		
61			X	D	156.075	160.675	Public Correspondence (Marine Operator), Port operation, ship movement		
61A	X	X		S	156.075		Public Coast: Coast Guard; East Coast: commercial fishing only		
62			X	D	156.125	160.725	Public Correspondence (Marine Operator), Port operation, ship movement		
62A		X		S	156.125		Public Coast: Coast Guard; East Coast: commercial fishing only		
63			X	D	156.175	160.775	Public Correspondence (Marine Operator), Port operation, ship movement		
63A	X	X		S	156.175		Port Operation and Commercial. VTS in selected areas.		
64		X	X	D	156.225	160.825	Public Correspondence (Marine Operator), Port operation, ship movement		
64A	X	X		S	156.225		Public Correspondence (Marine Operator), Port operation, ship movement		
65			X	D	156.275	160.875	Public Correspondence (Marine Operator), Port operation, ship movement		
65A	X	X		S	156.275		Port Operations		
66			X	D	156.325	160.925	Public Correspondence (Marine Operator), Port operation, ship movement		
66A	X	X		S	156.325		Port Operations		
67	X	X	X	S	156.375		US: Commercial. Used for Bridge- to-bridge communications in lower Mississippi River. Inter-ship only. Canada: Commercial fishing, S&R		
68	X	X	X	S	156.425		Non-commercial (Recreational)		
69	X	X	X	S	156.475		US: Non-commercial (Recreational), Canada: Commercial fishing only, International: Inter-ship, Port operations and Ship movement		
70	X	X	X	S	---	156.525	Digital selective calling (voice communications not allowed)		
71	X	X	X	S	156.575		US, Canada: Non-commercial (Recreational), International: Port operations and Ship movement		
72	X	X	X	S	156.625		Non-commercial (Inter-ship only)		
73	X	X	X	S	156.675		US: Port Operations, Canada: Commercial fishing only, International: Inter-ship, Port operations and Ship movement		

VHF MARINE CHANNEL CHART								
CH	U	C	I	S/D	TX	RX	CHANNEL USE	
74	X	X	X	S	156.725		US: Port Operations, Canada: Commercial fishing only, International: Inter-ship, Port operations and Ship movement	
75	X	X	X	S	156.775		Port Operations (Inter-ship only) (1W)	
76	X	X	X	S	156.825		Port Operations (Inter-ship only) (1W)	
77	X	X		S	156.875		Port Operations (Inter-ship only) (1W)	
77			X	S	156.875		Port Operations (Inter-ship only)	
78			X	D	156.925	161.525	Public Correspondence (Marine Operator), Port operation, ship-movement	
1078			X	S	156.925			
2078			X	S	161.525			
78A	X	X		S	156.925		Non-commercial (Recreational)	
79			X	D	156.975	161.575	Port operation and Ship movement	
1079			X	S	156.975			
2079			X	S	161.575			
79A	X	X		S	156.975		Commercial	
80			X	D	157.025	161.625	Port operation, ship movement	
80A	X	X		S	157.025		Commercial	
81			X	D	157.075	161.675	Port operation, ship movement	
81A	X			S	157.075		U.S. Government Only - Environmental protection operations.	
81A		X		S	157.075		Canadian Coast Guard Only	
82			X	D	157.125	161.725	Public Correspondence (Marine Operator), Port operation, ship movement	
82A	X	X		S	157.125		U.S. Government Only, Canadian Coast Guard Only	
83			X	D	157.175	161.775	Public Correspondence (Marine Operator)	
83A	X	X		S	157.175		U.S. Government Only, Canadian Coast Guard Only	
83B		X			---	161.775	CMB Service	
84	X	X	X	D	157.225	161.825	Public Correspondence (Marine Operator)	
85	X	X	X	D	157.275	161.875	Public Correspondence (Marine Operator)	
86	X	X	X	D	157.325	161.925	Public Correspondence (Marine Operator)	
87		X	X	S	157.375		Port operation, ship movement	
87A	X			S	157.375		Public Correspondence (Marine Operator)	
88		X	X	S	157.425		Port operation, ship movement	
88A	X			S	157.425		Commercial, Inter-ship Only	
WX01	X	X	X	D	---	162.550	Weather (receive only)	
WX02	X	X	X	D	---	162.400	Weather (receive only)	
WX03	X	X	X	D	---	162.475	Weather (receive only)	
WX04	X	X	X	D	---	162.425	Weather (receive only)	
WX05	X	X	X	D	---	162.450	Weather (receive only)	
WX06	X	X	X	D	---	162.500	Weather (receive only)	
WX07	X	X	X	D	---	162.525	Weather (receive only)	
WX08	X	X	X	D	---	161.650	Weather (receive only)	
WX09	X	X	X	D	---	161.775	Weather (receive only)	
WX10	X	X	X	D	---	163.275	Weather (receive only)	

NOTE: Simplex channels, 03A, 21A, 23A, 61A, 64A, 81A, 82A and 83A CANNOT be lawfully used by the general public in U.S.A. waters.

18 WARRANTY

Marine Products Limited Warranty

PLEASE NOTE

The following “Limited Warranty” is for valid for products that have been purchased in the United States and Canada. For limited Warranty details outside the United States, contact the dealer in your country.

STANDARD HORIZON (a division of YAESU U.S.A.) warrants, to the original purchaser only, each new Marine Communications Product (“Product”) manufactured and/or supplied by STANDARD HORIZON against defects in materials and workmanship under normal use and service for a period of time from the date of purchase as follows:

Fixed Mount and Portable Transceivers

1 year - if purchased before 01/01/91

3 years - if purchased between 01/01/91 and 01/01/94

3 years Waterproof - if purchased after 01/01/94

Loud hailers

1 year - if purchased before 01/01/91

3 years - if purchased after 01/01/91

Associated Chargers

1 year - if purchased before 01/01/91

3 years - if purchased after 01/01/91

Associated Batteries - 1 year. Note: Batteries will be deemed defective only if storage capacity drops below 80% of rated capacity or if leakage develops.

Associated Accessories - 1 year. Includes: Microphones/Handsets, External Speakers, Antennas, Carrying Accessories, Power Supplies, and Signaling Boards.

To receive warranty service, the purchaser must deliver the Product, transportation and insurance prepaid, to STANDARD HORIZON (a division of YAESU U.S.A.), Attention Marine repairs 6125 Phyllis Drive, Cypress, California 90630, U.S.A. Include proof of purchase indicating model, serial number, and date of purchase. STANDARD HORIZON will return the Product to the purchaser freight prepaid. Products purchased prior to January 1, 1991 will bear the STANDARD HORIZON warranty terms in effect prior to that date.

In the event of a defect, malfunction or failure of the Product during the warranty period, STANDARD HORIZON's liability for any breach of contract

or any breach of express or implied warranties in connection with the sale of Products shall be limited solely to repair or replacement, at its option, of the Product or part(s) therein which, upon examination by STANDARD HORIZON, appear to be defective or not up to factory specifications. STANDARD HORIZON may, at its option, repair or replace parts or subassemblies with new or reconditioned parts and subassemblies. Parts thus repaired or replaced are warranted for the balance of the original applicable warranty.

STANDARD HORIZON will not warrant installation, maintenance or service of the Products. In all instances, STANDARD HORIZON's liability for damages shall not exceed the purchase price of the defective Product.

This warranty only extends to Products sold within the 50 States of the United States of America and the District of Columbia.

STANDARD HORIZON will pay all labor to repair the product and replacement parts charges incurred in providing the warranty service except where purchaser abuse or other qualifying exceptions exist. The purchaser must pay any transportation expenses incurred in returning the Product to STANDARD HORIZON for service.

This limited warranty does not extend to any Product which has been subjected to misuse, neglect, accident, incorrect wiring by anyone other than STANDARD HORIZON, improper installation, or subjected to use in violation of instructions furnished by STANDARD HORIZON, nor does this warranty extend to Products on which the serial number has been removed, defaced, or changed. STANDARD HORIZON cannot be responsible in any way for ancillary equipment not furnished by STANDARD HORIZON which is attached to or used in connection with STANDARD HORIZON's Products, or for the operation of the Product with any ancillary equipment, and all such equipment is expressly excluded from this warranty. STANDARD HORIZON disclaims liability for range, coverage, or operation of the Product and ancillary equipment as a whole under this warranty. STANDARD HORIZON reserves the right to make changes or improvements in Products, during subsequent production, without incurring the obligation to install such changes or improvements on previously manufactured Products.

The implied warranties which the law imposes on the sale of this Product are expressly LIMITED, in duration, to the time period specified above. STANDARD HORIZON shall not be liable under any circumstances for consequential damages resulting from the use and operation of this Product, or from the breach of this LIMITED WARRANTY, any implied warranties, or any contract with STANDARD HORIZON. IN CONNECTION WITH THE SALE

OF ITS PRODUCTS, STANDARD HORIZON MAKES NO WARRANTIES, EXPRESS OR IMPLIED AS TO THE MERCHANTABILITY OR FITNESS FOR A PARTICULAR PURPOSE OR OTHERWISE, EXCEPT AS EXPRESSLY SET FORTH HEREIN.

Some states do not allow the exclusion or limitation of incidental or consequential damages, or limitation on how long an implied warranty lasts, so the above limitations or exclusions may not apply. This warranty gives specific legal rights, and there may be other rights which may vary from state to state.

ONLY PRODUCTS SOLD ON OR AFTER JANUARY 1, 1991 ARE COVERED UNDER THE TERMS OF THIS LIMITED WARRANTY.

ON-LINE WARRANTY REGISTRATION

THANK YOU for buying STANDARD HORIZON (a division of YAESU U.S.A.) products! We are confident your new radio will serve your needs for many years!

Please visit **www.standardhorizon.com** to register your Marine VHF. It should be noted that visiting the website from time to time may be beneficial to you, as new products are released they will appear on the STANDARD HORIZON website. Also a statement regarding product support should be added to the manual.

Product Support Inquiries

If you have any questions or comments regarding the use of the radio, you can visit the STANDARD HORIZON website to send an E-Mail or contact the Product Support team at (714) 827-7600 ext 6300 M-F 8:00-5:00PST.

In addition to the warranty, STANDARD HORIZON includes a lifetime "flat rate" and "customer loyalty" programs to provide service after the warranty period has expired. If you wish to obtain the flat rate price for out-of-warranty repair, you must include the information on the Owner's Record with the unit when you return it to your Dealer or to STANDARD HORIZON.

Lifetime Flat Rate Service Program: For the original Owner only, for the lifetime of the unit, STANDARD HORIZON will repair the unit to original specifications.

Note: The flat rate amount is payable by the Owner only if STANDARD HORIZON or the STANDARD HORIZON Dealer determines that a repair is needed. After the repair, a 90-day warranty will be in effect from the date of return of the unit to the Owner.

This service program is not available for equipment which has failed as a result of neglect, accident, breakage, misuse, improper installation or modification, or water damage (depending on the product).

19 RESET PROCEDURES



19.1 MEMORY CLEAR

To clear the scan memory and preset memory:

1. Turn the radio off.
2. Press and hold the three soft keys while turning the radio on.

19.2 MICROPROCESSOR RESET

To clear all memories and other settings to factory defaults (except the channel group, MMSI number, and DSC directory information):

1. Turn the radio off.
2. Press and hold the ,  and  keys while turning the radio on.

While resetting the radio, the radio will show the display as in the right for about 10 seconds, then turn on.

EE-PROM
Resetting

20 SPECIFICATIONS

Performance specifications are nominal, unless otherwise indicated, and are subject to change without notice.

20.1 GENERAL

Channels	All USA, International and Canadian
Normal Input Voltage	13.8 V DC
Operating Voltage Range	11 V to 16.5 V
Current Drain	
Standby	0.45 A
Receiver (at Maximum AF Output)	0.8 A
Transmit.....	5.0 A (Hi), 1.0 A (Lo)
Operating Temperature Range	-4 °F to +140 °F (-20 °C to +60 °C)
DSC Transmitted Call Log	24
DSC Distress Call Log	27
DSC Received Call Log	64
Individual Call Directory	80
Group Call Directory	32
Waypoint Directory	100
LCD Display Type	2.75" x 1.33" (70 x 34 mm) Full Dot Matrix (132 x 64 pixels)
Dimensions (WxHxD)	5.9" x 3.4" x 3.5" (150 x 85 x 90 mm)
Flush-Mount Dimensions (WxHxD)	5.4" x 2.8" x 2.6" (137 x 72 x 65 mm)
Weight	2.0 lbs (0.9 kg)

20.2 TRANSMITTER

Frequency Range	156.025 MHz to 161.600 MHz
RF Output Power	25 W (Hi), 1 W (Lo)
Conducted Spurious Emissions	Less than -80 dBc (Hi), -66 dBc (Lo)
Audio Response	within +1/-3dB of a 6 dB/Octave pre-emphasis characteristic at 300 to 3000 Hz
Audio Distortion	Less than 5 %
Modulation	16K0G3E (for Voice), 16K0G2B (for DSC)
Frequency Stability	±0.0003 % (-4 °F to +140 °F [-20 °C to +60 °C])
FM Hum and Noise	50 dB

20.3 RECEIVER

Frequency Range	156.050 MHz to 163.275 MHz
Sensitivity	
20 dB Quieting	0.35 μ V
12 dB SINAD	0.25 μ V
Squelch Sensitivity (Threshold)	0.13 μ V
Modulation Acceptance Bandwidth	\pm 7.5 kHz
Selectivity (Typical)	
Spurious and Image Rejection	80 dB for Voice (75 dB for DSC)
Intermodulation and Rejection	70 dB for Voice (70 dB for DSC)
Audio Output	4.5 W (at 4 ohms external speaker output)
Audio Response	within +1/-3dB of a 6 dB/Octave de-emphasis characteristic at 300 to 3000 Hz
Frequency Stability	\pm 0.0003 % (-4 °F to +140 °F [-20 °C to +60 °C])
Channel Spacing	25 kHz
DSC Format	ITU-R M.493-13

20.4 GPS UNIT (GX1700)

Receiver Channels	66 Channels
Sensitivity	Less than -147 dBm
Time to First Fix	1 minute typical (@Cold Start) 5 seconds typical (@ Hot Start)
Geodetic Datum	WGS84

20.5 NMEA INPUT/OUTPUT

NMEA 0183 GPS Input (4800 baud)	GSA, GSV, GGA, GLL, GNS, RMC
NMEA 0183 DSC Output (4800 baud)	DSC and DSE GSA, GSV, GGA, GLL, RMC (GX1700 when set to "On")

20.6 DIMENSIONS

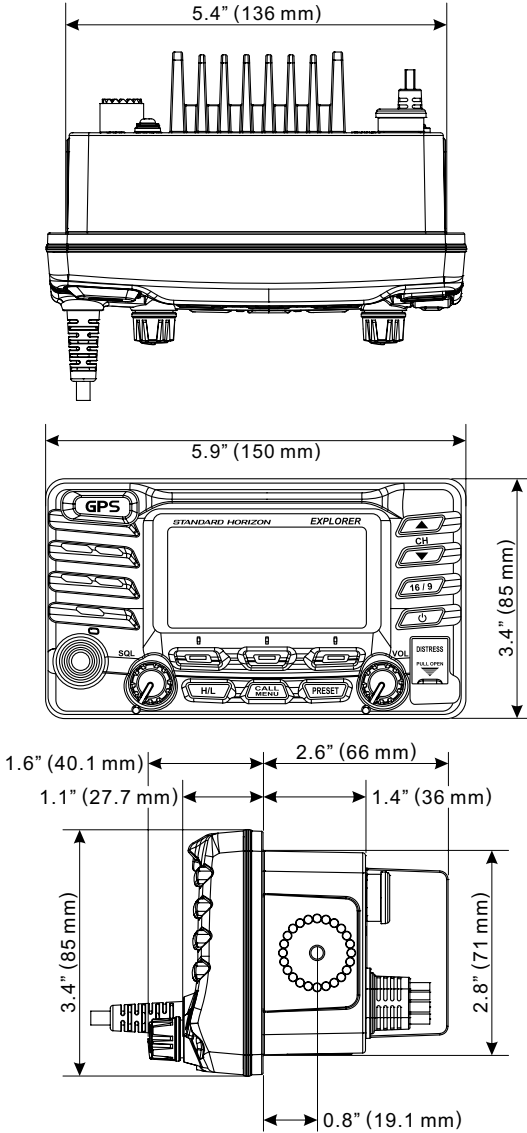

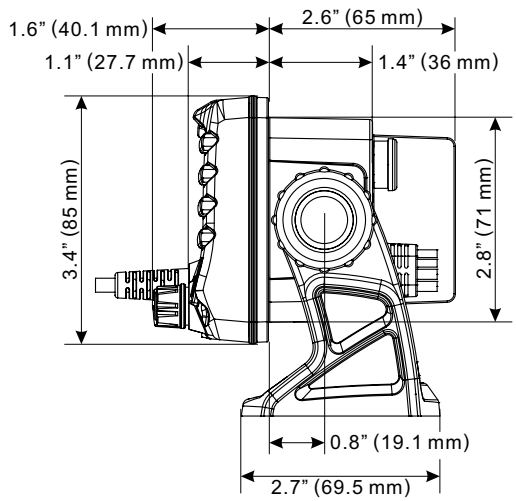
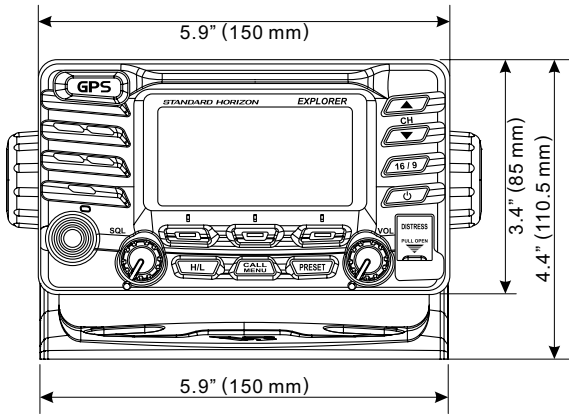
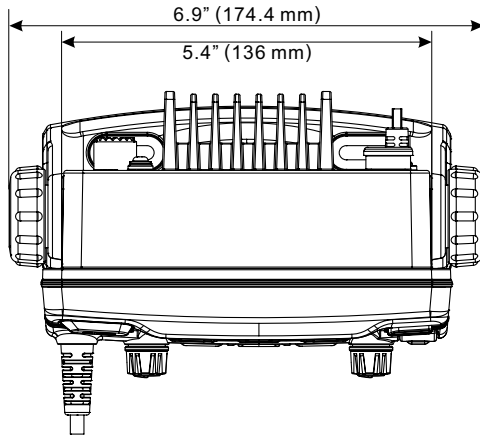

21 FCC RADIO LICENSE INFORMATION

Standard Horizon radios comply with the Federal Communication Commission (FCC) requirements that regulate the Maritime Radio Service.

21.1 STATION LICENSE

An FCC ship station license is no longer required for any vessel traveling in U.S. waters (except Hawaii) which is under 20 meters in length. However, any vessel required to carry a marine radio on an international voyage, carrying a HF single side band radiotelephone or marine satellite terminal is required to have a ship station license. FCC license forms, including applications for ship (605) and land station licenses can be downloaded via the Internet at <http://www.fcc.gov/Forms/Form605/605.html>. To obtain a form from the FCC, call (888) 225-5322.

21.2 RADIO CALL SIGN

Currently the FCC does not require recreational boaters to have a Ship Radio Station License. The USCG recommends the boats registration number and the state to be used when calling another vessel.

21.3 CANADIAN SHIP STATION LICENSING

You may need a license when traveling in Canada. If you need a license contact Industry Canada's nearest field office or regional office or write:

**Industry Canada
Radio Regulatory Branch
Attn: DOSP
300 Slater Street
Ottawa, Ontario
Canada, KIA 0C8**

21.4 FCC / INDUSTRY CANADA INFORMATION

The following data pertaining to the transceiver is necessary to fill out the license application.

Type Acceptance FCC Part 80
Output Power..... 1 Watt (low) and 25 Watts (high)
Emission 16K0G3E, 16K0G2B
Frequency Range 156.025 to 163.275 MHz
FCC Type Number.....K6630483X3D
Industry Canada Type Approval 511B-30483X3S

22 FCC NOTICE

NOTICE

Unauthorized changes or modifications to this equipment may void compliance with FCC Rules. Any change or modification must be approved in writing by STANDARD HORIZON.

NOTICE

This equipment has been tested and found to comply with the limits for a Class B digital device, pursuant to Part 15 of the FCC Rules. These limits are designed to provide reasonable protection against harmful interference in a residential installation. This equipment generates, uses and can radiate radio frequency energy and, if not installed and used in accordance with the instructions, may cause harmful interference to radio communications. However, there is no guarantee that interference will not occur in a particular installation. If this equipment does cause harmful interference to radio or television reception, which can be determined by turning the equipment off and on, the user is encouraged to try to correct the interference by one or more of the following measures:

- Reorient or relocate the receiving antenna.
- Increase the separation between the equipment and receiver.
- Connect the equipment into an outlet on a circuit different from that to which the receiver is connected.
- Consult the dealer or an experienced radio/TV technician for help.

This device complies with part 15 of the FCC rules. Operation is subject to the condition that this device does not cause harmful interference.

Part 15.21: Changes or modifications to this device not expressly approved by YAESU MUSEN could void the User's authorization to operate this device.

STANDARD HORIZON

YAESU USA

6125 Phyllis Drive, Cypress, California 90630.

www.standardhorizon.com



E M O 4 8 N 1 6 5

Copyright 2016

YAESU MUSEN CO., LTD.

All rights reserved.

No portion of this manual may be reproduced without the permission of YAESU MUSEN CO., LTD.

Printed in China